

DENON

RCD-M39
CD RECEIVER

Owner's Manual

SAFETY PRECAUTIONS



CAUTION
RISK OF ELECTRIC SHOCK
DO NOT OPEN



CAUTION:
TO REDUCE THE RISK OF ELECTRIC SHOCK, DO NOT REMOVE COVER (OR BACK). NO USER-SERVICEABLE PARTS INSIDE. REFER SERVICING TO QUALIFIED SERVICE PERSONNEL.

The lightning flash with arrowhead symbol, within an equilateral triangle, is intended to alert the user to the presence of uninsulated "dangerous voltage" within the product's enclosure that may be of sufficient magnitude to constitute a risk of electric shock to persons.

The exclamation point within an equilateral triangle is intended to alert the user to the presence of important operating and maintenance (servicing) instructions in the literature accompanying the appliance.

WARNING:
TO REDUCE THE RISK OF FIRE OR ELECTRIC SHOCK, DO NOT EXPOSE THIS APPLIANCE TO RAIN OR MOISTURE.

CLASS 1 LASER PRODUCT LUOKAN 1 LASERLAITE KLASS 1 LASERAPPARAT

"CLASS 1
LASER PRODUCT"

- ADVARSEL:** USYNLIG LASERSTRÅLING VED ÅBNING, NÅR SIKKERHEDSAFBRYDERE ER UDE AF FUNKTION. UNDGÅ UDSÆTTELSE FOR STRÅLING.
- VAROITUS!** LAITTEEN KÄYTTÄMINEN MUULLA KUIN TÄSSÄ KÄYTTÖOHJEESSA MAINITULLA TAVALLA SAATTAA ALTISTAA KÄYTTÄJÄN TURVALLISUUSLUOKAN 1 YLITTÄVÄLLE NÄKYMÄMTTÖMÄLLE LASERSÄTEILYLLE.
- WARNING:** OM APPARATEN ANVÄNDS PÅ ANNAT SÄTT ÄN I DENNA BRUKSANVISNING SPECIFICERATS, KAN ANVÄNDAREN UTSÄTTAS FÖR OSYNLIG LASERSTRÅLNING SOM ÖVERSKRIDER GRÄNSEN FÖR LASERKLASS 1.



ATTENZIONE: QUESTO APPARECCHIO E' DOTATO DI DISPOSITIVO OTTICO CON RAGGIO LASER. L'USO IMPROPRIO DELL'APPARECCHIO PUO' CAUSARE PERICOLOSE ESPOSIZIONI A RADIAZIONI!

IMPORTANT SAFETY INSTRUCTIONS

1. Read these instructions.
2. Keep these instructions.
3. Heed all warnings.
4. Follow all instructions.
5. Do not use this apparatus near water.
6. Clean only with dry cloth.
7. Do not block any ventilation openings. Install in accordance with the manufacturer's instructions.
8. Do not install near any heat sources such as radiators, heat registers, stoves, or other apparatus (including amplifiers) that produce heat.
9. Protect the power cord from being walked on or pinched particularly at plugs, convenience receptacles, and the point where they exit from the apparatus.
10. Only use attachments/accessories specified by the manufacturer.
11. Use only with the cart, stand, tripod, bracket, or table specified by the manufacturer, or sold with the apparatus. When a cart is used, use caution when moving the cart/apparatus combination to avoid injury from tip-over.
12. Unplug this apparatus during lightning storms or when unused for long periods of time.
13. Refer all servicing to qualified service personnel. Servicing is required when the apparatus has been damaged in any way, such as power-supply cord or plug is damaged, liquid has been spilled or objects have fallen into the apparatus, the apparatus has been exposed to rain or moisture, does not operate normally, or has been dropped.
14. Batteries shall not be exposed to excessive heat such as sunshine, fire or the like.



Hot
surface
mark

CAUTION: HOT SURFACE. DO NOT TOUCH.

The top surface over the internal heat sink may become hot when operating this product continuously. Do not touch hot areas, especially around the "Hot surface mark" and the top panel.

CAUTION:
USE OF CONTROLS OR ADJUSTMENTS OR PERFORMANCE OF PROCEDURES OTHER THAN THOSE SPECIFIED HEREIN MAY RESULT IN HAZARDOUS RADIATION EXPOSURE.
THIS PRODUCT SHOULD NOT BE ADJUSTED OR REPAIRED BY ANYONE EXCEPT PROPERLY QUALIFIED SERVICE PERSONNEL.

CAUTION:

To completely disconnect this product from the mains, disconnect the plug from the wall socket outlet. The mains plug is used to completely interrupt the power supply to the unit and must be within easy access by the user.

• DECLARATION OF CONFORMITY

We declare under our sole responsibility that this product, to which this declaration relates, is in conformity with the following standards: EN60065, EN55013, EN55020, EN61000-3-2 and EN61000-3-3. Following the provisions of Low Voltage Directive 2006/95/EC and EMC Directive 2004/108/EC, the EC regulation 1275/2008 and its frame work Directive 2009/125/EC for Energy-related Products (ErP).

DENON EUROPE
Division of D&M Germany GmbH
An der Kleinbahn 18, Nettetal,
D-41334 Germany

A NOTE ABOUT RECYCLING:

This product's packaging materials are recyclable and can be reused. Please dispose of any materials in accordance with the local recycling regulations.

When discarding the unit, comply with local rules or regulations.

Batteries should never be thrown away or incinerated but disposed of in accordance with the local regulations concerning battery disposal.

This product and the supplied accessories, excluding the batteries, constitute the applicable product according to the WEEE directive.



Pb

❑ NOTES ON USE

WARNINGS

- Avoid high temperatures.
Allow for sufficient heat dispersion when installed in a rack.
- Handle the power cord carefully.
Hold the plug when unplugging the cord.
- Keep the unit free from moisture, water, and dust.
- Unplug the power cord when not using the unit for long periods of time.
- Do not obstruct the ventilation holes.
- Do not let foreign objects into the unit.
- Do not let insecticides, benzene, and thinner come in contact with the unit.
- Never disassemble or modify the unit in any way.
- Ventilation should not be impeded by covering the ventilation openings with items, such as newspapers, tablecloths or curtains.
- Naked flame sources such as lighted candles should not be placed on the unit.
- Observe and follow local regulations regarding battery disposal.
- Do not expose the unit to dripping or splashing fluids.
- Do not place objects filled with liquids, such as vases, on the unit.
- Do not handle the mains cord with wet hands.
- When the switch is in the OFF (STANDBY) position, the equipment is not completely switched off from MAINS.
- The equipment shall be installed near the power supply so that the power supply is easily accessible.
- Do not keep the battery in a place exposed to direct sunlight or in places with extremely high temperatures, such as near a heater.

❑ CAUTIONS ON INSTALLATION

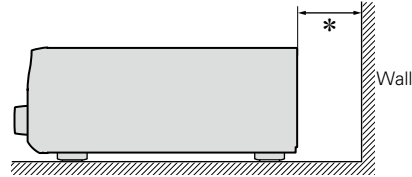
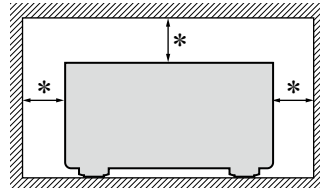

*** For proper heat dispersal, do not install this unit in a confined space, such as a bookcase or similar enclosure.**

- More than 0.3 m is recommended.
- Do not place any other equipment on this unit.

Getting started

Thank you for purchasing this DENON product. To ensure proper operation, please read this owner's manual carefully before using the product. After reading them, be sure to keep them for future reference.

Contents

Getting started	1
Accessories	1
Features	2
Cautions on handling	2
Preparations	3
Connections	4
Connecting the speakers	4
Connecting an iPod or USB memory device to the USB port	5
Connecting a TV	6
Connecting an antenna	6
Connecting the power cord	7
Operations	8
Basic operation	9
Preparations	9
Setting the current time (24-Hour Display)	10
Operations possible during playback	11
Playing CDs	12
Listening to FM broadcasts	14
Listening to DAB/DAB+ (for RCD-M39DAB only)	18
Listening to AUX	19
Advanced operation	20
Preparations	20
Playing of MP3 and WMA files	21
Playing an iPod	23
Playing a USB memory device	24
Setting the alarm	25
Other functions	27

Informations	28
Part names and functions	29
Front panel	29
Display	30
Rear panel	30
Remote control unit	31
Other information	34
Discs	34
Explanation terms	35
Troubleshooting	35
Specifications	37

Accessories

Check that the following parts are supplied with the product.

① Getting Started	1
② CD-ROM (Owner's manual)	1
③ Safety Instructions	1
④ Service network list	1
⑤ Remote control unit (RC-1162)	1
⑥ R03/AAA batteries	2
⑦ ① Power cord: for continental model only	1
② Power cord: for RCD-M39DAB only	1
⑧ FM indoor antenna (for continental model only)	1
⑨ DAB/FM indoor antenna (for RCD-M39DAB only)	1

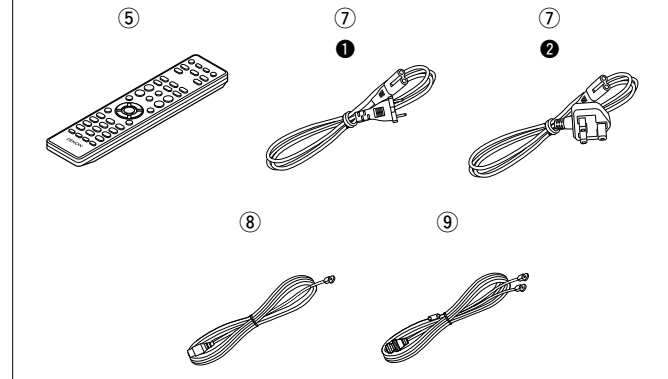

Features

High quality amplifier stressing sound quality

Equipped with a 30 W + 30 W (6 Ω) high-quality amplifier circuits.

Direct Play for iPod® and iPhone® via USB

Music data from an iPod can be played back if you connect the USB cable supplied with the iPod via the USB port of this unit, and also an iPod can be controlled with the Remote control unit for this unit.

Weight and Dramatic sound

The board and circuit configuration has been redesigned to achieve lower impedance. Since stable current is supplied to the power amp and other sections, it is possible to realize as much as 30 watts of power.

“Simple & Straight” circuit design for sound purity and free of coloration

DENON's popular M series gives you high sound quality based on the “simple & straight” concept. Circuitry is uncomplicated, signal paths are short, and all adverse influences on sound quality have been minimized.

This unit also provides the “Auto standby mode”, where it goes into the standby state when there is no operation for 30 minutes.

Playback of MP3 and WMA files

Supports playback of discs and USB memory devices on which MP3 or WMA files are recorded. The unit's display can display the title of the track and the name of the artist of the current track. Usable characters “Switching the display” ([page 13, 24](#))

Low standby power consumption

Designed with the environment in mind, the unit consumes just 0.3 W while in standby mode.

Remote control unit

This unit is shipped with a remote control unit that has large buttons for frequently used functions, allowing you to quickly find the desired function.

Cautions on handling

• Before turning the power switch on

Check once again that all connections are correct and that there are no problems with the connection cables.

- Power is supplied to some of the circuitry even when the unit is set to the standby mode. When leaving home for long periods of time, be sure to unplug the power cord from the power outlet.

• Proper ventilation

If the unit is left in a room full of smoke from cigarettes, etc., for long periods of time, the surface of the optical pickup may get dirty, preventing it from receiving signals properly.

• About condensation

If there is a major difference in temperature between the inside of the unit and its surroundings, condensation may form on parts inside the unit, causing it to fail to operate properly.

If this happens, let the unit sit for an hour or two with the power turned off and wait until there is little difference in temperature before using the unit.

• Cautions on using mobile phones

Using a mobile phone near this unit may result in noise. If that occurs, move the mobile phone away from the unit when it is in use.

• Moving the unit





Be sure to remove a disc, turn off the power and unplug the power cord from the power outlet. Next, disconnect the cables connected to other system units before moving the unit.

• About care

- Wipe the cabinet and control panel clean with a soft cloth.
- Follow the instructions when using a chemical cleaner.
- Benzene, paint thinner or other organic solvents as well as insecticide may cause material changes and discoloration if brought into contact with the unit, and should therefore not be used.

Preparations

Here, we explain the connection methods for this unit.

- Connecting the speakers  [page 4](#)
- Connecting an iPod or USB memory device to the USB port  [page 5](#)
- Connecting a TV  [page 6](#)
- Connecting an antenna  [page 6](#)
- Connecting the power cord  [page 7](#)

Connections

NOTE

- Do not plug in the power cord until all connections have been completed.
- When making connections, also refer to the owner's manual of the other components.
- Be sure to connect the left and right channels properly (left with left, right with right).
- Do not bundle power supply cords together with connection cables. Doing so can result in humming or noise.

Cables used for connections

Audio cable (sold separately)			
Subwoofer cable			
Speaker cable			
Optical cable			
Audio cable			

Connecting the speakers

Subwoofer with built-in amplifier

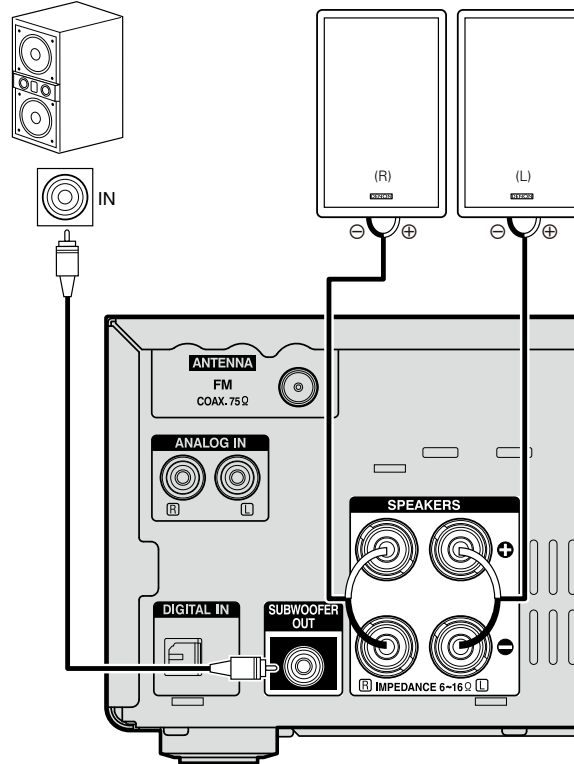

Connecting the speaker cables

Carefully check the left (L) and right (R) channels and + (red) and - (black) polarities on the speakers being connected to the unit, and be sure to connect the channels and polarities correctly.

1 Peel off about 10 mm of sheathing from the tip of the speaker cable, then either twist the core wire tightly or apply solder to it.



2 Turn the speaker terminal counterclockwise to loosen it.



3 Insert the speaker cable's core wire to all the way into the speaker terminal.

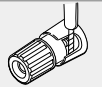

4 Turn the speaker terminal clockwise to tighten it.



NOTE

- Disconnect this unit's power plug from the power outlet before connecting the speakers. Also, turn off the subwoofer.
- Use speakers with an impedance of 6 to 16 Ω . The protection circuit may be activated if speakers with an impedance other than specified are used.
- Connect the speaker cables so they do not stick out of the speaker terminals. The protection circuit may be activated if the wires touch the rear panel or if the + and - sides touch each other (see [page 35](#) "Protection circuit").
- Never touch the speaker terminals while the power supply is connected. Doing so could result in electric shock.

Connecting an iPod or USB memory device to the USB port

- You can enjoy music stored on an iPod or USB memory device.
- For operating instructions see “Playing an iPod” (page 23) or “Playing a USB memory device” (page 24).

Cables used for connections

To connect an iPod to this unit, use the USB cable supplied with the iPod.

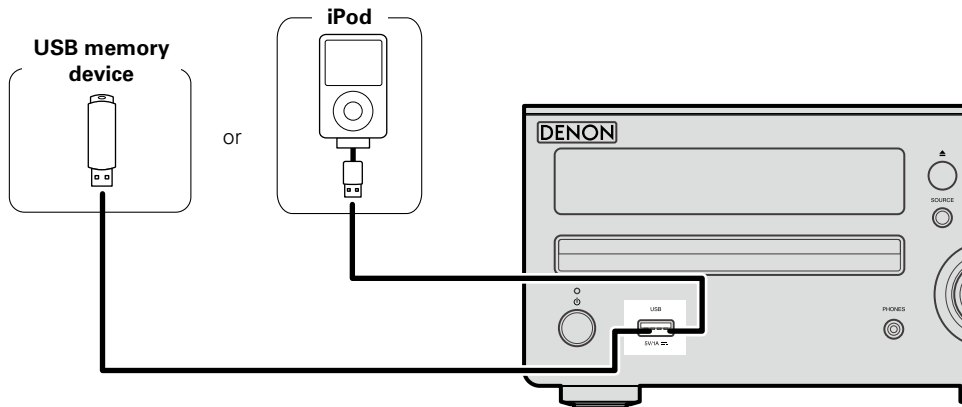

DENON does not guarantee that all USB memory devices will operate or receive power. When using a portable USB connection type HDD of the kind to which an AC adapter can be connected to supply power, use the AC adapter.

NOTE

- USB memory devices will not work via a USB hub.
- It is not possible to use this unit by connecting the unit's USB port to a PC via a USB cable.
- Do not use an extension cable when connecting a USB memory device. This may cause radio interference with other devices.
- When connecting an iPhone to this unit, keep the iPhone at least 20 cm away from this unit. If the iPhone is kept closer to this unit and a telephone call is received by the iPhone, noise may be output from this device.
- If the iPod is connected using an iPod cable (commercially available) that is longer than 2 m, sound may not be played correctly. In this case, use a genuine iPod cable, or a cable that is shorter than 1 m.

Supported iPod models

• iPod classic



iPod classic
80GB



iPod classic
160GB (2007)



iPod classic
160GB (2009)

• iPod nano



iPod nano
3rd generation (video)
4GB 8GB



iPod nano
4th generation (video)
8GB 16GB



iPod nano
5th generation (video camera)
8GB 16GB



iPod nano
6th generation
8GB 16GB

• iPod touch



iPod touch
1st generation
8GB 16GB 32GB



iPod touch
2nd generation
8GB 16GB 32GB



iPod touch
3rd generation
32GB 64GB



iPod touch
4th generation
8GB 32GB 64GB

• iPhone



iPhone
4GB 8GB 16GB



iPhone 3G
8GB 16GB



iPhone 3GS
8GB 16GB 32GB



iPhone 4
8GB 16GB 32GB



iPhone 4S
16GB 32GB 64GB

(as of June 2012)

Connecting a TV

- Select the connector to use and connect the device.
- To listen to TV audio through this unit, use the optical digital connection.

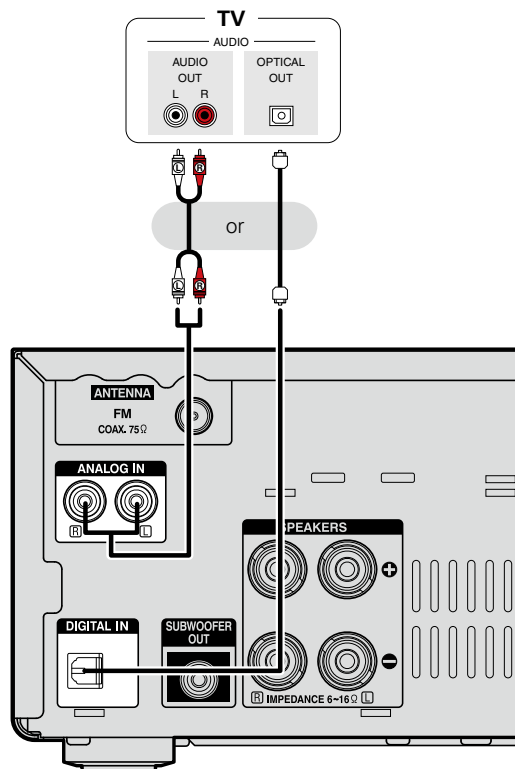

NOTE

- Other digital audio signals than 2 channel linear PCM cannot be input through DIGITAL IN (OPTICAL) connector of this unit.
- When you try to input digital audio signals other than 2 channel linear PCM to this unit, set the digital audio output setting of the TV to 2 channel PCM. For details, see the operating instructions of the TV.

Connecting an antenna

FM (for continental model only)

- Connect the FM antenna included with the unit to enjoy listening to radio broadcasts.
- After connecting the antenna and receiving a broadcast signal ([page 14](#) "Listening to FM broadcasts"), use tape to fix the antenna in a position where noise is the lowest.

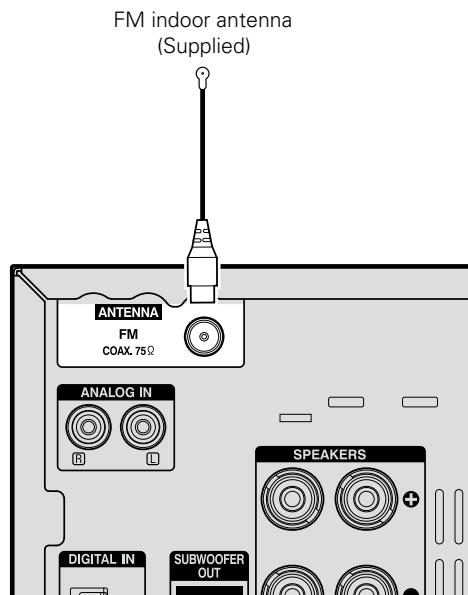

NOTE

- Do not connect two FM antennas simultaneously.
- If you are unable to receive a good broadcast signal, we recommend installing an outdoor antenna. Inquire at the retail store where you purchased the unit for details.

DAB/FM (for RCD-M39DAB only)

- **Connecting the DAB/FM indoor antenna**
DAB station reception ([page 18](#)).

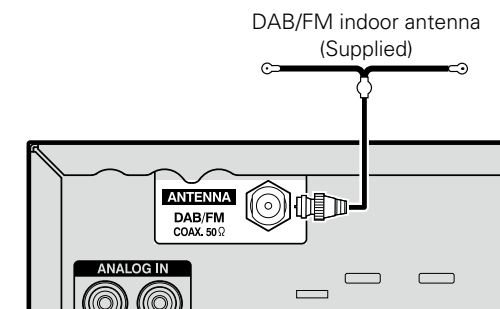

Connecting the power cord

For continental model only

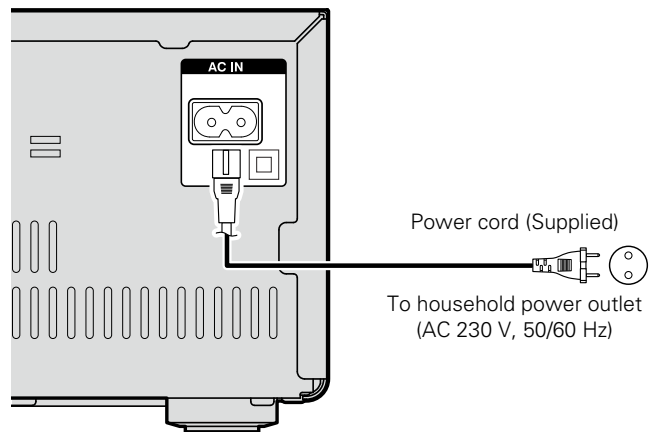

For RCD-M39DAB only

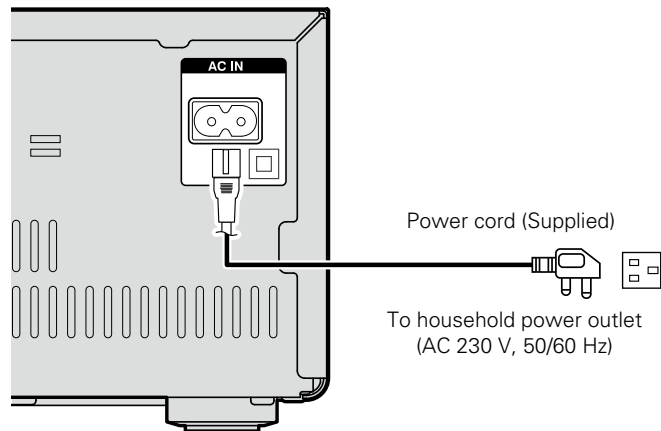

NOTE

- Only use the supplied power cord.
- Be sure the power cord is unplugged from the power outlet before connecting or disconnecting it to the AC IN.

Operations

Here, we explain functions and operations that let you make better use of this unit.

- Basic operation  [page 9](#)
- Advanced operation  [page 20](#)

Basic operation

- ❑ Turning the power on (👉 page 9)
- ❑ Before playing a disc (👉 page 9)
- ❑ Turning the power off (👉 page 9)

- ❑ Setting the current time (24-Hour Display) (👉 page 10)

- ❑ Selecting the input source (👉 page 11)
- ❑ Adjusting the master volume (👉 page 11)
- ❑ Adjusting the tone (👉 page 11)
- ❑ Turning off the sound temporarily (👉 page 11)
- ❑ Switching the display's brightness (👉 page 11)

- ❑ Playing CDs (👉 page 12)
- ❑ Listening to FM broadcasts (👉 page 14)
- ❑ Listening to DAB/DAB+ (for RCD-M39DAB only) (👉 page 18)

- ❑ Advanced operation (👉 page 20)

Preparations



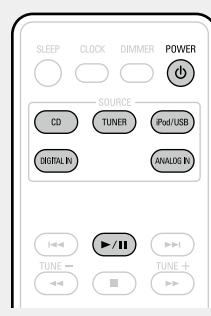

Turning the power on

Press POWER .

- The power turns on. Press again to set the power to standby.
- Power indicator
Normal standby.....Off
Power on.....Green
Alarm standby.....Orange
iPod charge standby.....Red



When the power is in the standby mode, pressing one of the following buttons also turns this unit on.

- ,  or * on the main unit
 - **CD, TUNER, iPod/USB, DIGITAL IN, ANALOG IN** or * on the remote control unit
- * If a disc has already been inserted, playback starts.

NOTE

- Power continues to be supplied to some of the circuitry even when the power is in the standby mode. When leaving home for long periods of time, unplug the power cord from the power outlet.
- Be sure to stop playback before turning the power off.

❑ Completely turning off the power

Unplug the power cord from the wall outlet.

- Note that the time setting is cleared when the power cord is unplugged from the outlet.
- The settings made for the various functions may be cleared if the power cord is left unplugged from a power outlet for an extended period of time.



Before playing a disc

1 Press POWER .

2 Press CD to set the input source to “DISC”.

If no disc is loaded “NO DISC” is displayed.

3 Insert a disc (👉 page 34).

- Press  on the main unit to open/close the disc tray.
- The disc tray also closes when  is pressed.

NOTE

Do not place any foreign objects in the disc tray. Doing so could damage it.

Turning the power off

Press POWER .

The power indicator turns off, and so does the power.



NOTE

- Be sure to stop playback before turning the power off.
- Make sure that the disc tray is completely shut before turning off the power.
- Do not push the disc tray in by hand when the power is turned off. Doing so could damage the set.

Setting the current time (24-Hour Display)

[Example] Setting the current time to 10:15 am

1 Press **POWER**  to turn the power on.

2 Press **SETUP**.
Various types of setting menus are displayed.

3 Use Δ / ∇ to select “**CLOCK SETUP**”, then press **ENTER** or \triangleright .



SETUP
CLOCK SETUP

4 Use Δ / ∇ to set the “hours”.



CLOCK SETUP
10:00

5 Press **ENTER** or \triangleright .
The “minutes” display flashes.

6 Use Δ / ∇ to set the “minutes”.



CLOCK SETUP
10:15

7 Press **ENTER** or \triangleright .
The current time is set, and the normal display reappears.



Checking the current time when the power is on

Press **CLOCK**.

Press once more and the display returns to its original condition.

Checking the current time when the power is set to standby

Press **CLOCK**.

The current time is displayed for 10 seconds.

NOTE

The time cannot be set when in the standby mode. Turn on the power first.

Operations possible during playback

Selecting the input source

Press **CD**, **TUNER**, **iPod/USB**, **DIGITAL IN** or **ANALOG IN** to select the input source.

The desired input source can be selected directly.

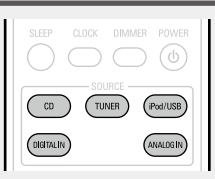

You can also use the following operation to select an input source.

Using the button on the main unit

Press **SOURCE**.

- Every time you press **SOURCE**, the input source switches in the following order.



Adjusting the master volume

Use **VOLUME ▲▼** to adjust the volume.

The volume level is displayed.

[Adjustable range]

VOLUME 00 – 49, VOLUME MAX

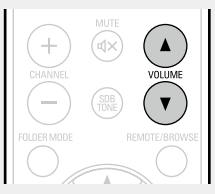

You can also adjust the volume this by turning **VOLUME** on the main unit.

Adjusting the tone

1 Press **SDB TONE** to select the tone parameter to be adjusted.

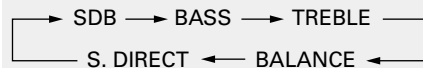

2 Use **<>** to adjust the **SDB**, **BASS**, **TREBLE** or **BALANCE**.

- To make other tone adjustments at this time, press **SDB TONE**.
- If no operation is performed for 5 seconds, the adjustment is retained and the normal display reappears.

- SDB** Emphasizes the bass sound when the Super Dynamic Bass (SDB) function is set to ON.
[Selectable modes] **ON** – **OFF**
- BASS** Adjusts the bass sound.
[Variable range] **-10dB** – **+10dB**
- TREBLE** Adjusts the treble sound.
[Variable range] **-10dB** – **+10dB**
- BALANCE** Adjusts the left/right volume balance.
[Variable range] **L06** – **CENTER** – **R06**
- S.DIRECT** Plays back a disc using the SOURCE DIRECT mode. During the SOURCE DIRECT mode, the audio signals bypass the tone control circuits (SDB/BASS/TREBLE/BALANCE), the music reproduction is more faithful to the original sound.

[Default settings]

- SDB OFF
- BASS 0dB
- TREBLE 0dB
- BALANCE CENTER
- S.DIRECT OFF

Turning off the sound temporarily

Press **MUTE** **<X>**.
"MUTE ON" is displayed.

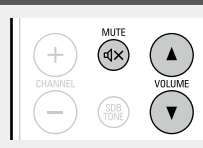

To cancel, press **MUTE** **<X>** again.
(The mute mode is also canceled when **VOLUME ▲▼** is pressed.)

Switching the display's brightness

Press **DIMMER**.

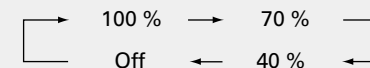

- The display's brightness switches each time the button is pressed.

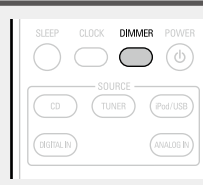

Playing CDs

Playing CDs

Before you start this operation, perform the procedure in “Before playing a disc” (page 9).

Press ►/II.

The ► indicator lights and playback begins.



□ Playing of MP3 and WMA files (page 21)

□ Stopping playback

Press ■.

- You can also perform this operation by pressing ■ (for continental model only) or **BAND/■** (for RCD-M39DAB model only) on the main unit.

□ Stopping playback temporarily

Press ►/II.

II is displayed.

- To resume playback, press ►/II.

□ Fast-forwarding and fast-reversing (searching)

During playback, press and hold in ◀◀, ▶▶.

□ Moving to the beginning of tracks (skipping)

During playback, press I◀◀, ▶▶I.

- The disc skips as many tracks as times the button is pressed.
- When you press reverse once, playback returns to the beginning of the current track.
- You can also perform this operation by pressing I◀◀/-, +/▶▶I on the main unit.

□ To play the desired track

Press 0 – 9, +10 to select the track.

[Example] Track 4 : 4

[Example] Track 12 : +10, 2

[Example] Track 20 : +10, +10, 0

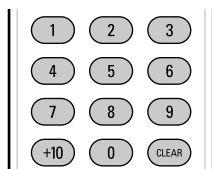

Playing repeatedly (Repeat playback)

Press REPEAT.

Playback in the respective repeat mode starts.

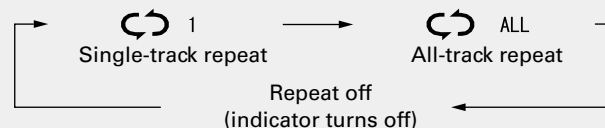
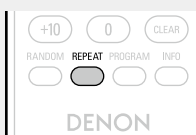

↻1 (Single-track repeat)	Only 1 track plays repeatedly.
↻ALL (All-track repeat)	All tracks play repeatedly.
Repeat off (indicator turns off)	Normal playback resumes.



The repeat playback mode is canceled if you open the disc tray or turn off power.

Playing random order (Random playback)

1 In the stop mode, press RANDOM.

The “RANDOM” indicator lights.

2 Press ►/II.

The tracks start playing in random order.

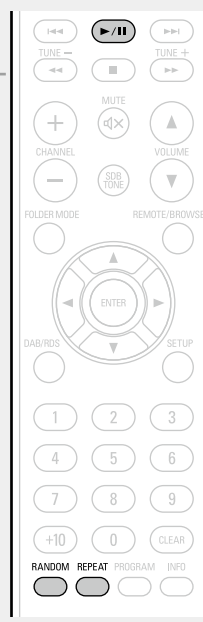

If **REPEAT** is pressed during random playback, after the current session of random playback is finished, another session in a different order of tracks starts.

NOTE

Random play cannot be set or canceled during playback.

□ Canceling random playback

While stopped, press **RANDOM**.

The “RANDOM” indicator turns off.



The random playback mode is canceled if you open the disc tray or turn off power.

Playing tracks in the desired order (Program playback)

Up to 25 tracks can be programmed.

1 In the stop mode, press PROGRAM.

"PGM" is displayed.

2 Use 0 – 9, +10 to select the tracks.

[Example] To program tracks 3, 12, 7 to play in that order:
Press **PROGRAM, 3, +10, 2, 7.**

3 Press ►/II.

Playback starts in the programmed order.

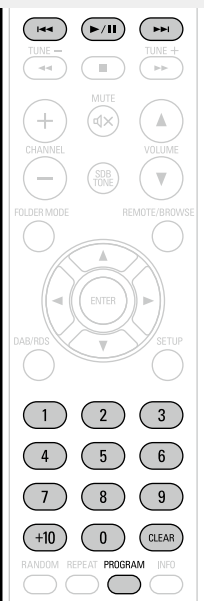

❑ Checking the order of the programmed tracks

In the stop mode, press ►►I.
The track numbers are displayed in the programmed order each time the button is pressed.

❑ To clear the last track programmed

In the stop mode, press CLEAR.
The last track programmed is cleared each time the button is pressed.

❑ To clear one programmed track at a time

In the stop mode, press ►►I to select the track to be cleared, then press CLEAR.

❑ Clearing the all programmed track

In the stop mode, press PROGRAM.



- If **REPEAT** is pressed during program playback, the tracks are played repeatedly in the programmed order.
- If **RANDOM** is pressed during program playback, the programmed tracks are played in random order.
- The program is cleared when the disc tray is opened or the power is turned off.

Switching the display

Press INFO.

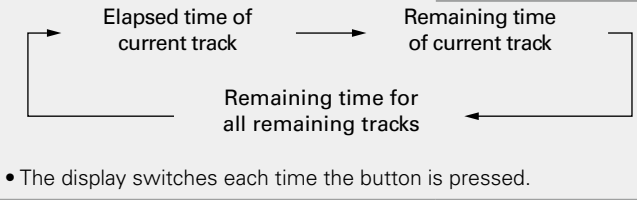
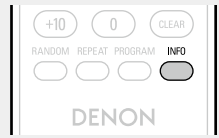

Listening to FM broadcasts

Tuning in broadcast stations

Connect the antenna beforehand (page 6).

1 Press TUNER to select the reception band.

- When "FM AUTO" is selected: "AUTO" is displayed.
- When "FM MONO" is selected: "MONO" is displayed.

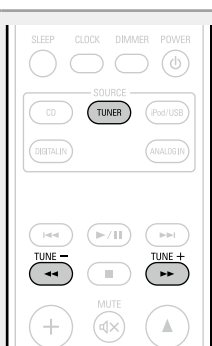

- You can also perform this operation by pressing **BAND/■** on the main unit. (For RCD-M39DAB only)
- When the reception band mode is set to "FM AUTO", the "ST" indicator lights when a stereo broadcast is tuned in.

2 Use TUNE -, + to select the reception band.

When a station is received, the "TUNED" indication will light.



If the signal is weak and stable stereo reception is not possible, select "FM MONO" to receive in monaural.

□ To tune automatically

Press and hold in **TUNE -, +** to tune in stations automatically.

- Stations whose signal is weak cannot be tuned in.
- In the DAB mode, tuning only moves to receivable stations, so auto tuning is not possible. (For RCD-M39DAB only)

□ To stop auto tuning

Press **TUNE -, +**.

Automatically presetting FM/DAB stations (Auto preset)

This unit can be preset with a total of 40 DAB and FM broadcast stations.

- A maximum of 30 DAB broadcast stations can be preset. (For RCD-M39DAB only)

□ Auto presetting with the remote control unit

Perform this operation when tuned to an FM or DAB broadcast station.

1 Press SETUP.

2 Use Δ∇ to select "TUNER SETUP", then press ENTER or ▷.

3 Use Δ∇ to select "FM AUTO PRESET", then press ENTER or ▷.

4 Press ENTER while "PRESET ENTER" is flashing.

Broadcast stations are preset automatically.



□ Canceling auto presetting

Press **TUNER** or **■**.



Broadcast stations whose antenna signal are weak cannot be preset automatically. If you wish to preset such stations, tune them in manually.

NOTE

When FM auto preset is performed, the channel currently registered as the FM preset is deleted, and the newly preset FM broadcast station is registered to the same number as the deleted channel.

□ Giving station names to preset channels

Names of up to 8 characters can be input.

1 Tune in the preset channel you want to name.

2 Press ENTER twice.

The display switches to the station name input display.

3 Input the station name.

Names of up to 8 characters can be input.

- Δ, ∇ button..... Selects the character.
- ▷ button Moves the cursor to the right.
- **CLEAR** button..... Deletes the currently selected character.

- Characters that can be input.

A ~ Z, 0 ~ 9, ^ ' () * + , - . / = (space)

4 Press ENTER.

The characters you have input are entered.

- To give names to other stations, repeat steps 1 to 4.

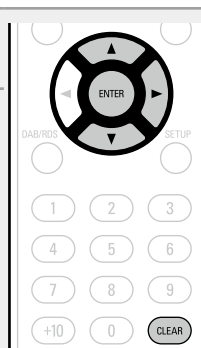

Presetting FM stations manually

This unit can be preset with a total of 40 FM broadcast stations.

1 Tune in the station you want to preset.

2 Press ENTER.
The minimum number display "P--" for the unregistered preset flashes.

3 Use 0 – 9, +10 or CHANNEL –, + to select the number to be preset, then press ENTER.

The reception frequency and reception mode are preset and the display switches to the station name input display.

NOTE

When the registered preset number is selected, "*" is displayed. To overwrite this preset number, press **ENTER**.

FM * P 0 1
1 0 6 . 9 5 MHz

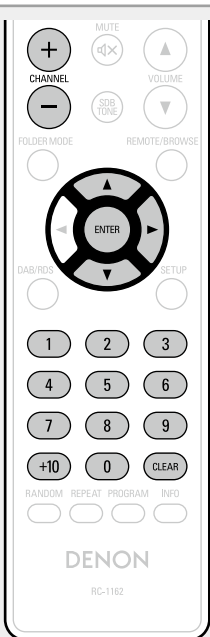

4 Input the station name.

Names of up to 8 characters can be input.

- Δ , ∇ button..... Selects the character.
- \triangleright button Moves the cursor to the right.
- **CLEAR** button..... Deletes the currently selected character.
- Characters that can be input.

A ~ Z, 0 ~ 9, ^ ' () * + , - . / = (space)

- If you do not want to input a station name, press **ENTER** without inputting anything else.
- If you make a mistake when inputting, perform the procedure again. Whatever was previously input is overwritten.

5 Press ENTER.

The characters you have input are entered.

- To give names to other stations, repeat steps 1 to 5.

Listening to preset stations

Use **0 – 9, +10 or CHANNEL –, +** to select the preset number.

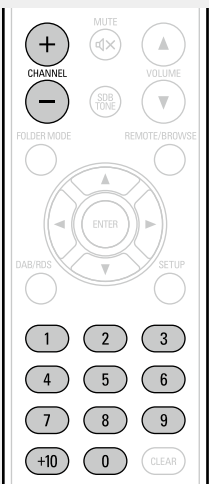

Setting the preset channels and changing the received frequency on the main unit

◀◀/–, +/▶▶ on the main unit can be used both for switching the preset channel and for tuning.

Before operating them, switch the main unit to the "preset mode" or "tuning mode" using the procedure below.

1 Press SETUP.

2 Use Δ ∇ to select "TUNER SETUP", then press ENTER or \triangleright .

3 Use Δ ∇ to select "MODE SELECT", then press ENTER or \triangleright .

4 Use Δ ∇ to select "PRESET MODE" or "TUNING MODE", then press ENTER.



PRESET MODE

Press **◀◀/–, +/▶▶** on the main unit to switch preset channels.

- This is the same operation as **CHANNEL –, +** on the remote control unit.

TUNING MODE

Press **◀◀/–, +/▶▶** on the main unit to change the received frequency.

- This is the same operation as **TUNE–, +** on the remote control unit.

RDS (Radio Data System)

RDS (works only on the FM band) is a broadcasting service which allows a station to send additional information along with the regular radio program signal.

The following four types of RDS information can be received with this unit:

❑ RDS Search

Use this function to automatically tune to FM stations that provide the RDS service.

- 1 Press TUNER to select "FM".**
- 2 Press DAB/RDS.**
- 3 Use Δ / ∇ to select "RDS SEARCH", then press ENTER or \blacktriangleright .**
- 4 Press \triangleleft / \blacktriangleright .**
Automatically begin the RDS search operation.
 - If no RDS station is found, "NO STATION" is displayed.

Viewing information during reception

Press **INFO** while receiving a RDS to display the information currently being broadcast.

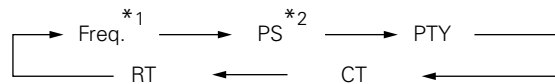

*1 Frequency

*2 Program service name

• If a station name is entered, it is displayed.

PTY (Program Type)

PTY identifies the type of RDS program.

The program types and their displays are as follows:

NEWS	News	WEATHER	Weather
AFFAIRS	Current Affairs	FINANCE	Finance
INFO	Information	CHILDREN	Children's programmes
SPORT	Sports	SOCIAL	Social Affairs
EDUCATE	Education	RELIGION	Religion
DRAMA	Drama	PHONE IN	Phone In
CULTURE	Culture	TRAVEL	Travel
SCIENCE	Science	LEISURE	Leisure
VARIED	Varied	JAZZ	Jazz Music
POP M	Pop Music	COUNTRY	Country Music
ROCK M	Rock Music	NATION M	National Music
EASY M	Easy Listening Music	OLDIES	Oldies Music
LIGHT M	Light Classical	FOLK M	Folk Music
CLASSICS	Serious Classical	DOCUMENT	Documentary
OTHER M	Other Music		

❑ PTY search

Use this function to find RDS stations broadcasting a designated program type (PTY).

For a description of each program type, refer to "Program Type (PTY)".

- 1 Press TUNER to select "FM".**
- 2 Press DAB/RDS.**
- 3 Use Δ / ∇ to select "PTY SEARCH", then press ENTER or \blacktriangleright .**
- 4 Use Δ / ∇ to call out the desired program type.**
- 5 Press \triangleleft / \blacktriangleright .**
Automatically begin the PTY search operation.
 - If no program of the specified type is found, "NO STATION" is displayed.

TP (Traffic Program)

TP identifies programs that carry traffic announcements. This allows you to easily find out the latest traffic conditions in your area before leaving home.

TP search

Use this function to find RDS stations broadcasting traffic programs (TP stations).

- 1** Press **TUNER** to select “FM”.
 - 2** Press **DAB/RDS**.
 - 3** Use Δ / ∇ to select “TP SEARCH”, then press **ENTER** or \triangleright .
 - 4** Press \triangleleft / \triangleright .
Automatically begin the TP search operation.
- “NO STATION” is displayed when there is no traffic information broadcast station.



RT (Radio Text)

RT allows RDS stations to send text messages that appear on the display.



- When the RT mode is turned on while an RDS broadcast station not offering an RT service is tuned in, “NO RT” is displayed on the display.
- The RT mode cannot be set in the FM stations not offering RDS broadcasts.

NOTE

The operations described below selecting “RDS Search” will not function in areas in which there are no RDS broadcasts.

CT (Clock Time)

Use this to correct the time of the clock on this unit.

- ① During CT reception, press **SETUP**.
The “AUTO Adj mm:ss” is displayed.
- ② Press **ENTER** to set.
The “RDS mm:ss” is displayed.
 - The time on the set’s internal clock is updated to the currently displayed “CT” time.



Do not operate any buttons while the time is being updated. If buttons are operated, CT reception is not possible and the time is not updated.

Listening to DAB/DAB+ (for RCD-M39DAB only)

□ About DAB (Digital Audio Broadcasting)

- Since the DAB system is broadcasted in digital format, DAB system can supply crystal-clear audio and stable reception even in mobile objects. DAB is a new generation radio which can provide data service and supplementary multi-media services.
- DAB broadcasts multiple services under one Ensemble that are called service components.
- Each component contains inherent programmes; news, music, sports, and many more.
- Each Ensemble and service component has its label, and users can recognize a current broadcasting station and service contents by using the label.
- The main service component is broadcast as Primary while the others are broadcast as Secondary.
- Also rich character information is serviced through Dynamic Labels; song title, artist composer etc.

□ About DAB+

- The main difference between DAB and DAB+ is the type of audio codec used.
 - DAB: MPEG2
 - DAB+: MAEG4 (AAC)
- This unit can receive both DAB and DAB+ broadcasts.

Tuning in DAB stations

1 Press TUNER to select “DAB”.

- When a DAB operation is performed for the first time after purchase, auto scanning is performed automatically.

2 Press TUNE +, - to select the desired broadcast station.

- The broadcast stations are displayed in the order in which they were scanned.

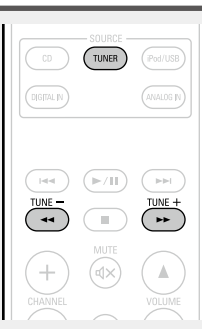

DAB stations can be stored in the preset memory and played in the same way as FM stations.

- “Presetting FM stations manually” ([page 15](#))
- “Listening to preset stations” ([page 15](#))
- A maximum of 30 DAB broadcast stations can be preset.

Auto scanning broadcast stations

Connect the antenna beforehand.

1 Press SETUP during DAB reception.

2 Use Δ∇ to select “TUNER SETUP”, then press ENTER or ▷.

3 Use Δ∇ to select “DAB AUTO SCAN”, then press ENTER or ▷.

4 Press ENTER.

This unit searches for receivable DAB stations.

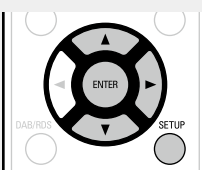

Switching the reception information for the currently tuned in DAB station

1 Perform steps 1 to 2 under “Tuning in DAB stations” to tune in a DAB station.

2 Press INFO.

- The display switches as shown below each time the button is pressed.



- ① **Dynamic Label Segment :**
Text data included in the broadcast is scrolled.
- ↓
- ② **Station Name :**
The service station name is displayed.
- ↓
- ③ **Program Type :**
The category of the tuned in station is displayed.
- ↓
- ④ **Ensemble Name :**
The ensemble name is displayed.
- ↓
- ⑤ **Frequency:**
The frequency is displayed.
- ↓
- ⑥ **Signal Quality :**
The reception signal sensitivity is displayed (0 to 8).
 - If the reception signal sensitivity is 7 or greater, the program can be received without noise.
- ↓
- ⑦ **Audio Information :**
The mode of the currently tuned in station and its bit rate are displayed.
- ↓
- ⑧ **Date and Time :**
The current date and time are displayed.
 - When **SETUP** is pressed, the set's internal clock is updated to the currently displayed time.

Making the DAB settings

1 Press **DAB/RDS** during **DAB** reception.

2 Use $\Delta \nabla$ to select “item”, then press **ENTER**.

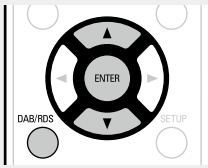

Tuning Aid

The reception sensitivity of the currently tuned in frequency is displayed.

- The program can be received without noise when the cursor move to the right of the sensitivity display. _____|_____

Station Order

The service list is created with the auto scan function.

MULTIPLEX (In order of frequency) \longleftrightarrow ALPHANUMERIC (In alphabetical order)

DRC

(Dynamic Range Control)

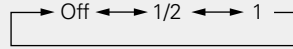

DAB Version

The DAB module's version is displayed.

DAB initialize

When the “DAB Initialize” procedure is performed, all the preset memory settings for the stations and DABs are reset.

1 Press **SETUP** during **DAB** reception.

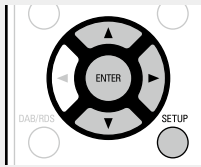

2 Use $\Delta \nabla$ to select “TUNER SETUP”, then press the **ENTER** or \triangleright .

3 Use $\Delta \nabla$ to select “DAB INITIALIZE”, then press the **ENTER** or \triangleright .

4 Press **ENTER**.

- Once initialization is completed, auto scanning is performed automatically.

Listening to AUX

1 Prepare for playback.

Check the connection, then turn on this units.

2 Press **DIGITAL IN** or **ANALOG IN**.

- When there is no component connected to the DIGITAL IN connector, “SIGNAL UNLOCK” is not displayed when you press **DIGITAL IN**.

3 Play the component connected to this unit.



Advanced operation

❑ **Basic operation** (👉 [page 9](#))

❑ **Before playing a USB or an iPod** (👉 [page 20](#))

❑ **MP3 or WMA playback order of MP3 or WMA files**
(👉 [page 20](#))

❑ **Playing of MP3 and WMA files** (👉 [page 21](#))

❑ **Playing an iPod** (👉 [page 23](#))

❑ **Playing a USB memory device** (👉 [page 24](#))

❑ **Setting the alarm** (👉 [page 25](#))

❑ **Other functions** (👉 [page 27](#))

Preparations

Before playing a USB or an iPod

1 Press **POWER** .

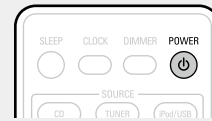

2 Connect **USB memory device or iPod connection cable** (👉 [page 5](#)).

When the USB memory device or iPod is connected to the USB port on this unit, the source automatically switches to "USB" and file playback begins.

❑ **Turning the power off (to the standby mode)**

Press **POWER**  again.

NOTE

Be sure to stop playback before turning the power off.

MP3 or WMA playback order of MP3 or WMA files

When there are multiple folders containing MP3 or WMA files, the playback order of folders is automatically set when this unit reads the media. The files in each folder are played back in the order in which the files were recorded on the media, from the oldest date and time.

❑ **Playback order of folders**

CD-R/CD-RW

For playback of files on CD-R or CD-RW, files in all folders on the first layer are played first, next on the second layer, then next on the third layer, and so on in this order.

USB memory device

For playback of files recorded on USB, files in the first folder on the first layer are played first, next folders on the second layer in the folder, then next on the third layer, and so on in this order. Then accordingly files on another first layer are played.



- The playback order displayed on a PC may differ from the actual playback order.
- The playback order with a CD-R/CD-RW may differ, depending on the writing software.

NOTE

The playback order may differ from the order in which the folders or files were recorded if you delete or add a folder or file on USB. This occurs because of data recording specifications and is not a malfunction.

Playing of MP3 and WMA files

There are many music distribution sites on the Internet allowing you to download music files in MP3 or WMA (Windows Media® Audio) format. The music (files) downloaded from such sites can be stored on CD-R or CD-RW discs and played on this unit.

“Windows Media” and “Windows” are registered trademarks or trademarks in the United States and other countries of Microsoft Corporation of the United States.

MP3 and WMA formats

CD-R and CD-RW discs created in the format described below can be played.

Writing software format

ISO9660 Level 1

When written in other formats, it may not be possible to play the disc properly.

Maximum number of playable files and folders

Number of files : 255

Number of folders : 255

File format

MPEG-1 Audio Layer-3

WMA (Windows Media Audio)

Tag data

ID3-Tag (Ver. 1.x and 2.x)

META-Tag

(Compatible with title, artist and album names)

Playable MP3/WMA file			
File format	Sampling frequency	Bit rate	Extension
MP3	32, 44.1, 48 kHz	32 ~ 320 kbps	.mp3
WMA	32, 44.1, 48 kHz	64 ~ 192 kbps	.wma



- Be sure to give files the extension “.MP3” or “.WMA”. Files with any other extensions or with no extensions cannot be played.
- In accordance with copyright laws, recordings you have made should only be used for your personal enjoyment and may not be used in other ways without permission of the copyright holder.

MP3 and WMA files playback

1 Load a CD-R or CD-RW disc containing music files in the MP3 or WMA format into the disc tray (page 34).

2 Press **FOLDER MODE** and select “Folder Mode” or “Disc Mode”.

Folder Mode ←→ Disc Mode

[About the display]

- When “Folder Mode” is selected: “FLD” indicator lights.
- When “Disc Mode” is selected: “FLD” indicator turns off.

Folder Mode All the files in the selected folder are played.

Disc Mode After the selected folder and files are played, all the files in all the folders are played.

3 Use Δ / ∇ to select the folder to be played.

4 Use \lll , \ggg or \triangleleft , \triangleright to select the file to be played.

5 Press \triangleright /II.



To switch the folder or file during playback

Folder

Use Δ / ∇ to select the folder, then press **ENTER**.

File

Use \triangleleft / \triangleright to select the file, then press **ENTER**.

Also use **I**/**II**, **III** to select the file, or use **0-9**, **+10** to select the file number.

- The folder and file numbers are set automatically when the disc is loaded.



- Copyright-protected files cannot be played.
- Depending on the application software used for writing, it may not be possible to write the data properly.
- Depending on the disc's recording conditions, it may not be possible to play some discs properly.

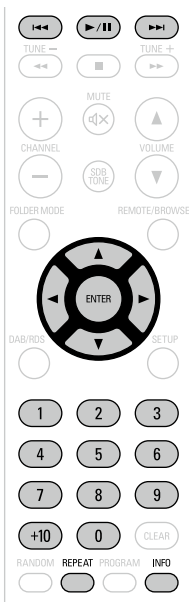

Switching the display

During playback, press **INFO**.



- The characters that can be displayed are as follows:

A-Z a-z 0-9

! " # \$ % & : ; < > ? @ \ [] _ ` | { } ^ ' () * + , - . / = (space)

To play repeatedly

Press **REPEAT**.

Playback starts in the respective repeat mode.

- The selectable repeat modes differ in the "Folder Mode" and the "Disc Mode".

When "Folder Mode" is selected:

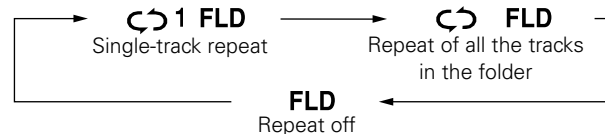

When "Disc Mode" is selected:

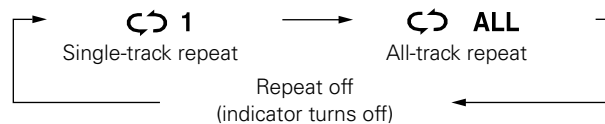

[Selectable items]

When "Folder Mode" is selected:

C2 1 FLD Only the selected track is played repeatedly.

C2 FLD All the files in the selected folder are played repeatedly.

FLD Folder mode playback resumes.

When "Disc Mode" is selected:

"Playing repeatedly (Repeat playback)" ([page 12](#))

Setting random playback

"Playing random order (Random playback)" ([page 12](#))



Programmed playback is not possible with MP3/WMA discs.

Playing an iPod

With this unit, you can listen to music on an iPod. It is also possible to operate the iPod from the main unit or remote control unit.



“Made for iPod” and “Made for iPhone” mean that an electronic accessory has been designed to connect specifically to iPod, or iPhone, respectively, and has been certified by the developer to meet Apple performance standards.

Apple is not responsible for the operation of this device or its compliance with safety and regulatory standards.

iPhone, iPod, iPod classic, iPod nano, iPod shuffle, and iPod touch are trademarks of Apple Inc., registered in the U.S. and other countries.

iPhone is a trademark of Apple Inc.

- Individual users are permitted to use iPhone, iPod, iPod classic, iPod nano, iPod shuffle, and iPod touch for private copy and playback of non-copyrighted contents and contents whose copy and playback is permitted by law. Copyright infringement is prohibited by law.

NOTE

- Depending on the type of iPod and the software version, some functions may not operate.
- Note that DENON will accept no responsibility whatsoever for any problems arising with the data on an iPod when using this unit in conjunction with the iPod.

1 Playback preparation
(☞ [page 20](#) “Before playing a USB or an iPod”).

2 Press REMOTE/BROWSE to select the display mode.

The mode switches each time the button is pressed.



	[Selectable mode]	Browse mode	Remote mode
Display location		Main unit display	iPod display
Playable files	Audio file	✓	✓
	Video file		✓
Active buttons	Remote control unit and main unit	✓	✓
	iPod		✓

3 Use Δ∇ to select the item, then press ENTER to select the music file to be played.

4 Press ▶/||.
Playback starts.

Remote control unit and iPod button relations

Remote control buttons	iPod buttons	Operation on this unit
▶/	▶/	Play the track / Pause the track.
◀◀, ▶▶	◀◀, ▶▶	Play the track from the beginning/ Play the next track.
◀◀, ▶▶ Press and hold	◀◀, ▶▶ Press and hold	Fast-reverse the track/Fast-forward the track.
Δ, ∇	Click Wheel	Select an item.
ENTER or ▶	Select	Enter the selection or plays the track.
REMOTE/BROWSE	-	Switch between the browse mode and the remote mode.
REPEAT	-	Switch the repeat function
RANDOM	-	Switch the shuffle function
◀	MENU	Display the menu or return to the previous menu.
■	-	Stop

To switch the display

During playback, press **INFO**.

The display switches each time the button is pressed.



Disconnecting the iPod

1 Press POWER to set the standby mode.



2 Disconnect the iPod cable from the USB port.



By pressing **POWER** while the power of this unit is on with iPod being connected, this unit enters the iPod charge standby mode, continuing to charge iPod. In this case, the power indicator lights in red. When iPod is fully charged, the power indicator lights off.

Playing a USB memory device

Playable USB memory formats

Files stored on USB memory devices created in the formats below can be played.

❑ USB-compatible file systems

“FAT16” or “FAT32”

- If the USB memory device is divided into multiple partitions, only the top drive can be selected.

❑ Maximum number of playable files and folders

Maximum number of files in a folder: 255

Maximum number of folders: 255

❑ File format

MPEG-1 Audio Layer-3

WMA (Windows Media Audio)

❑ Tag data

ID3-Tag (Ver.1.x and 2.x)

META-Tag

(Compatible with title, artist and album names)

Playable MP3/WMA file			
File format	Sampling frequency	Bit rate	Extension
MP3	32, 44.1, 48 kHz	32 ~ 320 kbps	.mp3
WMA	32, 44.1, 48 kHz	64 ~ 192 kbps	.wma



Only music files that are not copyright-protected can be played on this set.

- Contents downloaded from pay sites on the Internet are copyright protected. Also, files encoded in WMA format when ripped from a CD, etc., on a computer may be copyright protected, depending on the computer's settings.

Playing a USB memory device

1 Playback preparation
([page 20](#) “Before playing a USB or an iPod”).

2 Press **FOLDER MODE** and select “Folder Mode” or “Memory Mode”.

- When “Folder Mode” is selected: “FLD” indicator lights.
- When “Memory Mode” is selected: “FLD” indicator turns off.

Folder Mode

All the files in the selected folder are played.

Memory Mode

After the selected folder and files are played, all the files in all the folders are played.

3 Use Δ / ∇ to select the folder to be played.

4 Use \lll , \ggg or \triangleleft , \triangleright to select the file to be played.

5 Press \blacktriangleright /**II**.

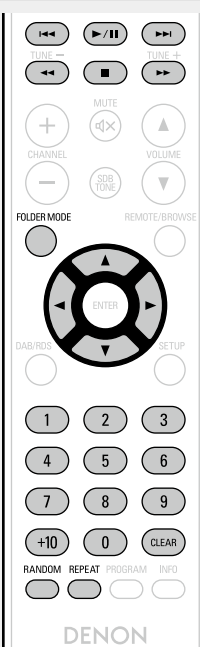

For details on the order of playback for files stored on a USB memory device, see “MP3 or WMA playback order of MP3 or WMA files” ([page 20](#)).

❑ To switch the folder or file during playback

Folder

Use Δ / ∇ to select the folder, then press **ENTER**.

File

Use \triangleleft / \triangleright to select the file, then press **ENTER**.

Use \lll , \ggg to select the file, or use **0 – 9**, **+10** to select the file number.

- The folder and file numbers are set automatically when the USB memory device is loaded.

❑ Stopping playback

Press **■**.

❑ Stopping playback temporarily

Press \blacktriangleright /**II**.

The **II** is displayed.

- To resume playback, press \blacktriangleright /**II**.

❑ Fast-forwarding and fast-reversing (searching)

During playback, press and hold in \lll , \ggg .

❑ Playing repeatedly

Press **REPEAT**.

❑ Playing random order

In the stop mode, press **RANDOM**.

Switching the display

During playback, press **INFO**.



The characters that can be displayed are as follows:

A-Z a-z 0-9

! " # \$ % & ; : < > ? @ \ [] _ ` | { } ^ ^ ' () * + , - . / = (space)

NOTE

- DENON will take no responsibility whatsoever for any loss or damage to data on USB memory devices when using the USB memory device connected to this unit.
- USB memory devices will not work via a USB hub.
- DENON does not guarantee that all USB memory devices will operate or be supplied power. When using a USB connection type portable hard disk of the type for which power can be supplied by connecting an AC adapter, we recommend using the AC adapter.

Setting the alarm

This device can playback using the alarm playback (everyday alarm, once alarm) and sleep timer.

Alarm operation when the time settings for alarms overlap

When the sleep timer is set

- Automatically stops playback after the time set for the sleep timer has elapsed.

When the once alarm and everyday alarm are both set (sleep timer is not set)

- Automatically starts playback at the earlier alarm start time set for either of the alarms.
- Automatically stops playback at the earlier alarm stop time set for either of the alarms.



If the current time is not set, enter alarm setting mode to get time setting mode.

Setting the alarm

Everyday alarm ("EVERYDAY ALARM")

Playback starts and stops (the power turns off) at the set times each day.

Once alarm ("ONCE ALARM")

Playback starts and stops (the power turns off) once only at the set times.

1 Press **SETUP**.

2 Use Δ / ∇ to select "ALARM SETUP", then press **ENTER** or \triangleright .

3 Use Δ / ∇ to select the alarm mode, then press **ENTER** or \triangleright .

MODE SELECT
ONCE ALARM

ONCE ALARM ↔ EVERYDAY ALARM

4 Use Δ / ∇ to select the source, then press **ENTER** or \triangleright .

SOURCE SELECT
DISC

DISC ↔ iPod/USB ↔ TUNER
DIGITAL IN ↔ ANALOG IN



5 Only when the "TUNER" function is selected

Use Δ / ∇ to select the preset number, then press **ENTER** or \triangleright .

- When no name has been registered for the selected preset number, the frequency appears after the preset number is displayed.

6 Use Δ / ∇ to select “hours” for the alarm start time, then press **ENTER** or \triangleright .



7 Use Δ / ∇ to select “minutes” for the alarm start time, then press **ENTER** or \triangleright .



8 Use Δ / ∇ to select “hours” for the alarm stop time, then press **ENTER** or \triangleright .

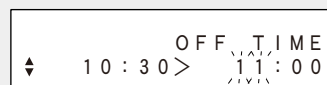

9 Use Δ / ∇ to select “minutes” for the alarm stop time, then press **ENTER** or \triangleright .

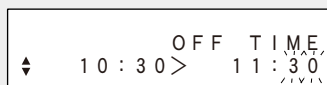

10 Use \triangleleft / \triangleright to select “ON” or “OFF” for the alarm, then press **ENTER**.

• The L indicator lights and the alarm setting is entered.



• The alarm settings are displayed for 3 seconds.



11 Press **POWER** P to set the power to standby. Alarm standby mode is set, and the power indicator lights orange.

Setting the alarm to on or off

- ① Press **SETUP**.
- ② Use Δ / ∇ to select “ALARM ON/OFF”, then press **ENTER**.
- ③ Use Δ / ∇ to select “ONCE” or “EVERYDAY”.
- ④ Use \triangleleft / \triangleright to select “ON” or “OFF” for the alarm, then press **ENTER**. The alarm settings are displayed after this.

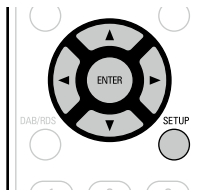

• When set to “OFF”, time operation is disabled, but the alarm settings remain unchanged.

To check the alarm settings

- ① Press **SETUP**.
- ② Use Δ / ∇ to select “ALARM ON/OFF”, then press **ENTER**.
- ③ When “ON” is displayed for the alarm setting, press **ENTER**. The alarm settings are displayed for 3 seconds.

To change the alarm settings

Perform the operations at “Setting the alarm” ([page 25](#)).

To change the setting while setting the alarm

Press \triangleleft . The setting returns to the previous step. Display the setting you want to change, then make the desired setting.

Setting the sleep timer

Use this function to automatically switch the power to the standby mode after a specific amount of time (minutes). The sleep timer can be set to up to 90 minutes, in steps of 10 minutes.

Press SLEEP during playback and select the setting time.

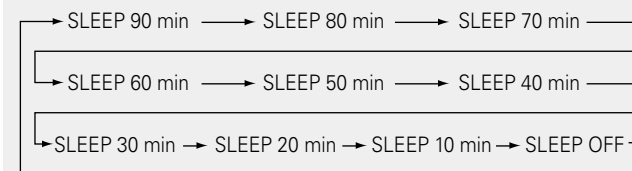

• After about 5 seconds, the setting is entered and the display returns to as it was before.

Canceling the sleep timer

Either press **SLEEP** to select “SLEEP OFF” or press **POWER** P .

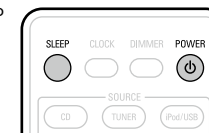

To check the time remaining until the sleep timer is activated

Press **SLEEP**.

Other functions

Using an optimizing filter

An optimizing filter suited for the properties of the speakers (SC-M39) can be used.

1 Press **SETUP**.

2 Use Δ / ∇ to select “**SPK OPTIMISE**”, then press the **ENTER** or \triangleright .

3 Use Δ / ∇ to select “**ON**”, then press the **ENTER** or \triangleright . The setting is entered.

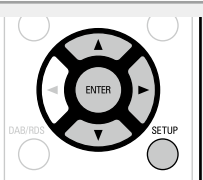

ON The response is optimized for the speakers (SC-M39, sold separately).

OFF The response is flat.

Auto power on

When the power is in standby, the power turns on when any of the buttons below other than **POWER** $\text{\textcircled{P}}$ is operated, and the respective operation is performed.

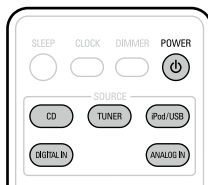

- \blacktriangle (on the main unit)..... The disc tray opens.
- \blacktriangleright / \parallel Playback of the “CD”, “iPod” or “USB” starts.
- **CD**..... The source switches to “DISC”.
- **TUNER**..... The source switches to “TUNER” and the band last set is tuned in.
- **iPod/USB**..... The source switches to “iPod/USB”.
- **DIGITAL IN**..... The source switches to “DIGITAL IN”.
- **ANALOG IN**..... The source switches to “ANALOG IN”.

Auto standby

With the Auto standby ON, this unit will automatically enter the standby mode after about 30 continuous minutes of stop mode with no operation.

For the input source “ANALOG IN” only, when no operation is performed for eight hours, this unit automatically enters the standby mode.

1 Press **SETUP**.

2 Use Δ / ∇ to select “**AUTO STANDBY**”, then press **ENTER** or \triangleright .

3 Use Δ / ∇ to select “**ON**”, then press **ENTER** or \triangleright . The setting is entered.

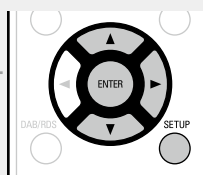

NOTE

In the following situations, the Auto standby function does not operate.

- When an iPod (Remote mode) is connected to the USB port on the unit.
- When the source is “TUNER”.
- The default setting for the Auto Standby mode is “ON”.

Last function memory

This stores the settings as they were immediately before going into the standby mode.

When the power is turned back on, the settings are restored to as they were immediately before going into the standby mode.

Resetting the microprocessor

Perform this procedure if the display is abnormal or if operations cannot be performed.

When the microprocessor is reset, all the settings are reset to their default values.

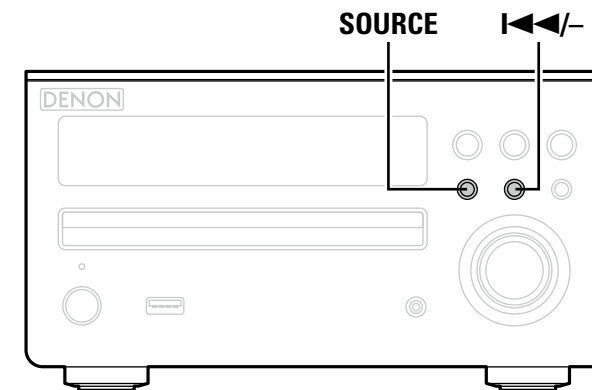

1 Unplug the power cord.





2 Plug the power cord into a power outlet while simultaneously pressing **I<<</>-** and **SOURCE** on the main unit. “INITIALIZE” is displayed.



If “INITIALIZE” does not display in step 2, start over from step 1.

Informations

Here, we list various information related to this unit.
Please refer to this information as needed.

- Part names and functions  [page 29](#)
- Other information  [page 34](#)
- Troubleshooting  [page 35](#)
- Specifications  [page 37](#)
- Index  [page 37](#)

Part names and functions

Front panel

For buttons not explained here, see the page indicated in parentheses ().

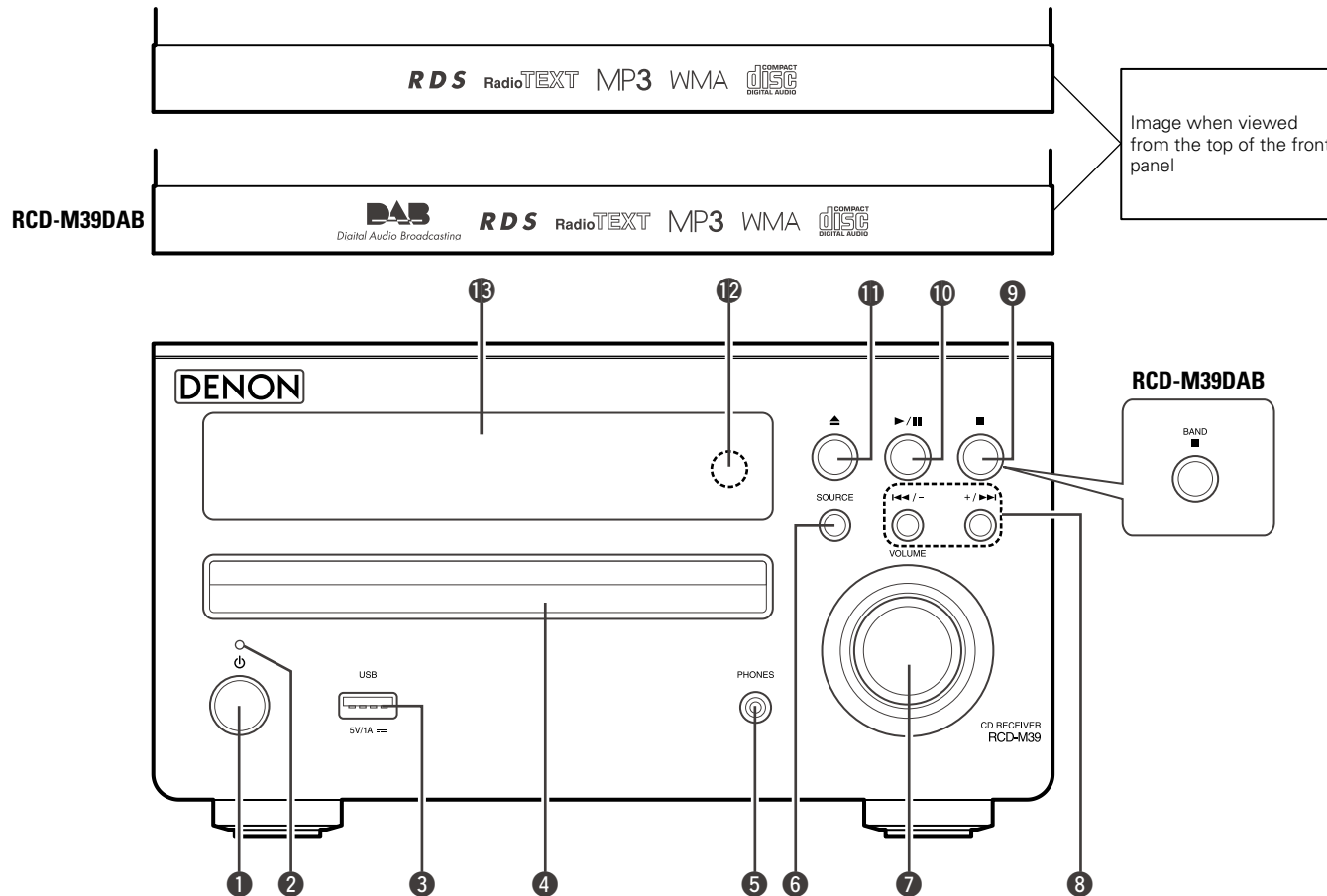

- ❶ **Power operation button (⏻)** (9, 20)
- ❷ **Power indicator** (9)
- ❸ **USB port** (5)
- ❹ **Disc tray** (34)
- ❺ **Headphones jack (PHONES)**
When the headphones are plugged into this jack, audio will no longer be output from the connected speakers.
- NOTE**
To prevent hearing loss, do not raise the volume level excessively when using headphones.
- ❻ **SOURCE button** (11, 27)
- ❼ **VOLUME control knob** (11)
- ❽ **Reverse-skip/Forward-skip buttons**
Preset/Tuning buttons
(⏪/⏩, +/⏮) (12, 15, 21, 24, 27)
- ❾ **Stop button (■)**
(for continental model only) (12, 14, 24)
Band/Stop button (BAND/■)
(for RCD-M39DAB model only) (12, 14, 24)
- ❿ **Play/Pause button (▶/⏸)** (9, 12, 21, 23, 24)
- ⓫ **Disc tray open/close button (⏏)** (9)
- ⓬ **Remote control sensor** (33)
- ⓭ **Display**

Display

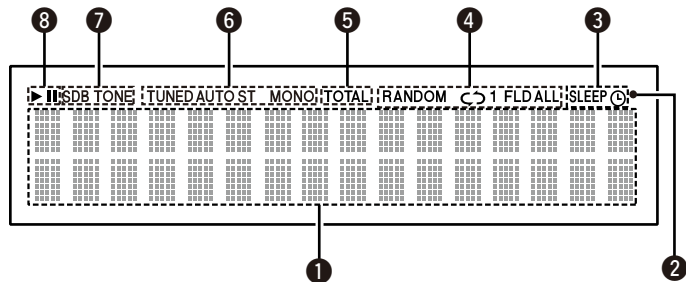

1 Information display

Various information is displayed here.

2 Remote control signal reception indicator

3 Timer operation indicator

4 Play mode indicator (12, 22, 24)

5 TOTAL indicator

Lights when the total number of tracks and total time of the CD are displayed.

6 Tuner reception mode indicators (14)

7 Tone indicators (11)

SDB: Lights when the super dynamic bass function is set to "ON".

TONE: Lights when the tone (bass/treble) is being adjusted.

8 Playback mode indicators

▶: During Playback

||: During pause

Rear panel

For buttons not explained here, see the page indicated in parentheses ().

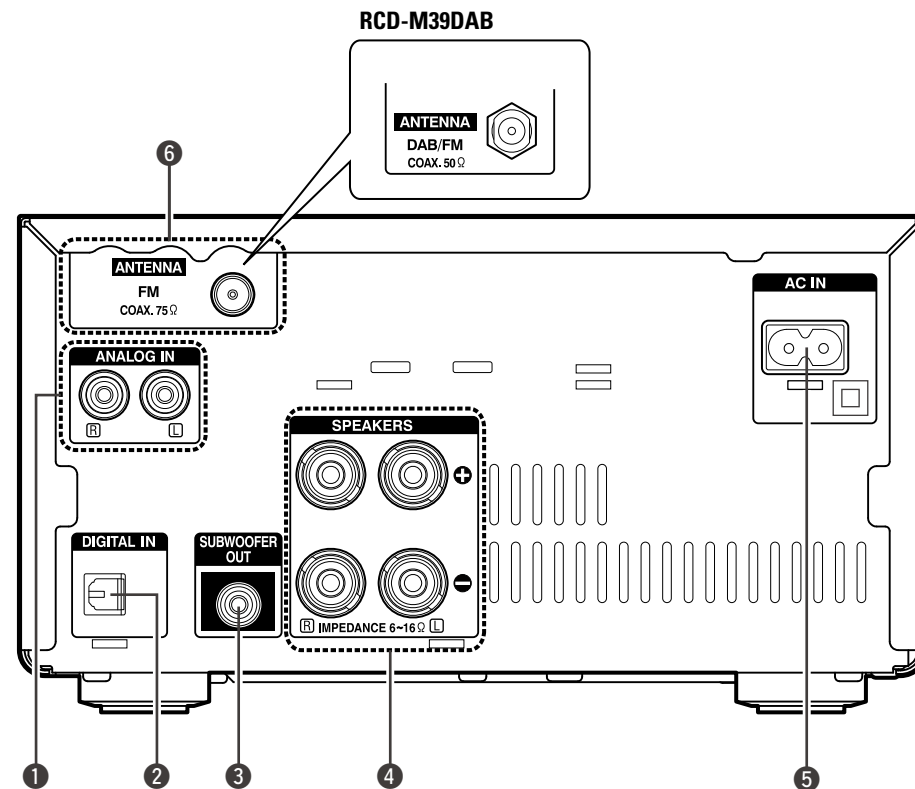

1 Analog audio connectors (ANALOG IN) (6)

2 Digital audio connector (DIGITAL IN) (6)

3 Subwoofer connector (SUBWOOFER OUT) (4)

4 Speaker terminals (SPEAKERS) (4)

5 AC inlet (AC IN) (7)

6 FM antenna terminal (ANTENNA) (for continental model only) (6)

DAB/FM antenna terminal (ANTENNA) (for RCD-M39DAB only) (6)

Remote control unit

This section explains the buttons used to playback each source.

Buttons that work with all sources (CD, TUNER, iPod and USB)

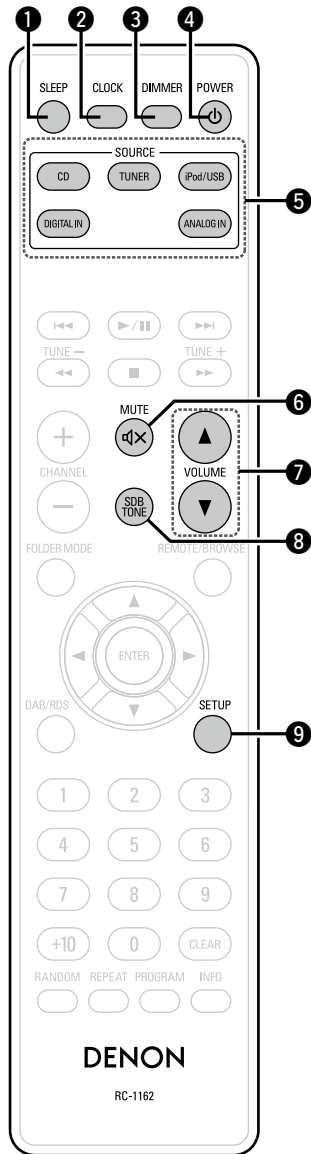

- 1 SLEEP button (26)
- 2 CLOCK button (10)
- 3 DIMMER button (11)
- 4 POWER button (⏻) (9, 20)
- 5 SOURCE buttons (11, 27)
- 6 MUTE button (⏸) (11)
- 7 VOLUME buttons (▲ ▼) (11)
- 8 SDB TONE button (11)
- 9 SETUP button (10, 14, 15, 18, 25, 27)

Buttons that work with CDs

The buttons listed at "Buttons that work with all sources" can also be used.

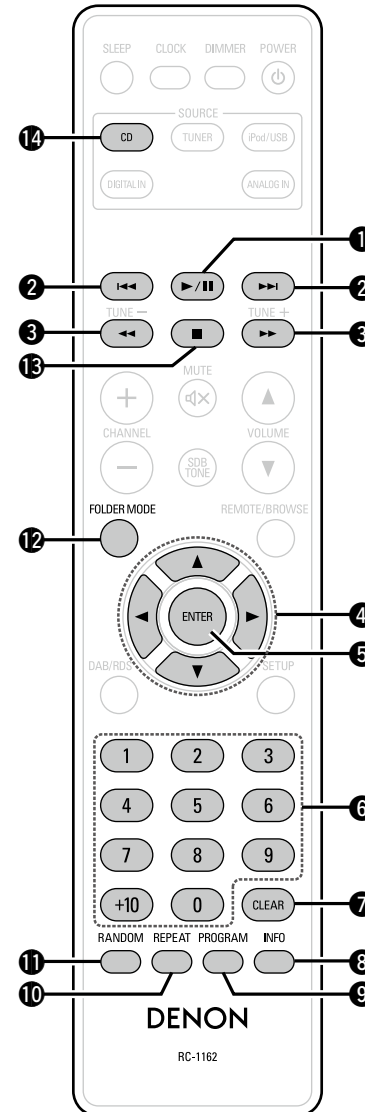

- 1 Play/Pause button (▶/⏸) (9, 12)
- 2 Reverse-skip/Forward-skip buttons (◀◀, ▶▶) (12, 21)
- 3 Fast-reverse/Fast-forward buttons (◀◀, ▶▶) (12)
- 4 Cursor buttons (▲▼◀▶) (21)
- 5 ENTER button (22)
- 6 Number buttons (0 – 9, +10) (12, 22)
- 7 CLEAR button (13)
- 8 Information button (INFO) (13, 22)
- 9 PROGRAM button (13)
- 10 REPEAT button (12, 22)
- 11 RANDOM button (12)
- 12 FOLDER MODE button (21)
- 13 Stop button (■) (12)
- 14 SOURCE button (CD) (9)

Buttons that work with the tuner

The buttons listed at "Buttons that work with all sources" can also be used.

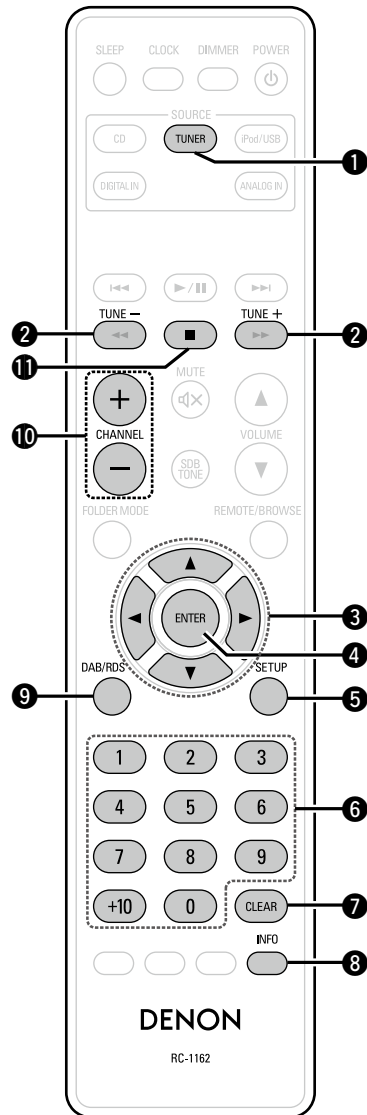

- 1 SOURCE button (TUNER) (14)
- 2 Tuning buttons (TUNE +, -) (14, 18)
- 3 Cursor buttons (Δ▽◀▶) (14, 18)
- 4 ENTER button (14, 18)
- 5 SETUP button (14, 18)
- 6 Number buttons (0 - 9, +10) (15)
- 7 CLEAR button (14)
- 8 Information button (INFO) (16, 18)
- 9 DAB/RDS button (16, 19)
- 10 CHANNEL buttons (+, -) (15)
- 11 Stop button (■) (14)

Buttons that work with iPods or USBs

The buttons listed at "Buttons that work with all sources" can also be used.

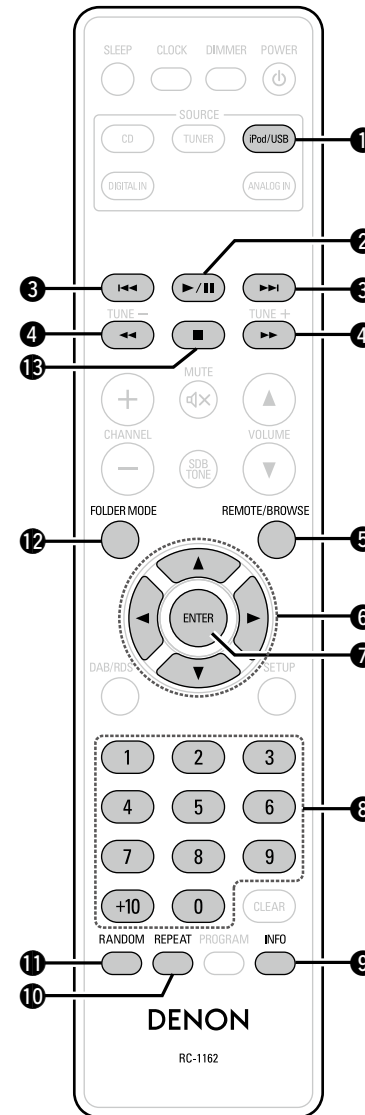

- 1 SOURCE button (iPod/USB) (11)
- 2 Play/Pause button (▶/||) (23, 24)
- 3 Reverse-skip/Forward-skip buttons (◀◀, ▶▶) (23, 24)
- 4 Fast-reverse/Fast-forward buttons (◀◀, ▶▶) (23, 24)
- 5 REMOTE/BROWSE button (23)
- 6 Cursor buttons (Δ▽◀▶) (23, 24)
- 7 ENTER button (23, 24)
- 8 Number buttons (0 - 9, +10) (22)
- 9 Information button (INFO) (23)
- 10 REPEAT button (23, 24)
- 11 RANDOM button (23, 24)
- 12 FOLDER MODE button (24)
- 13 Stop button (■) (24)

Inserting the batteries

- ① Remove the rear lid in the direction of the arrow and remove it.
- ② Load the two batteries properly as indicated by the marks in the battery compartment.

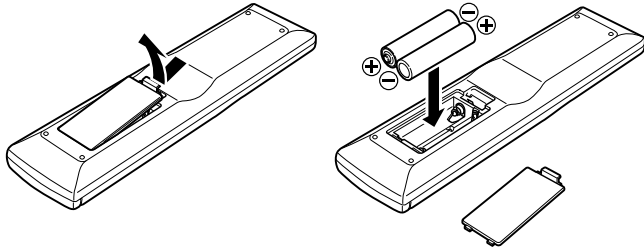

- ③ Put the rear cover back on.

NOTE

- Insert the specified batteries in the remote control unit.
- Replace the batteries with new ones if the set does not operate even when the remote control unit is operated close to the unit. (The supplied batteries are only for verifying operation. Replace them with new batteries at an early date.)
- When inserting the batteries, be sure to do so in the proper direction, following the ⊕ and ⊖ marks in the battery compartment.
- To prevent damage or leakage of battery fluid:
 - Do not use a new battery together with an old one.
 - Do not use two different types of batteries.
 - Do not attempt to charge dry batteries.
 - Do not short-circuit, disassemble, heat or dispose of batteries in flames.
 - Do not keep the battery in a place exposed to direct sunlight or in places with extremely high temperatures, such as near a heater.
- If the battery fluid should leak, carefully wipe the fluid off the inside of the battery compartment and insert new batteries.
- Remove the batteries from the remote control unit if it will not be in use for long periods.
- Used batteries should be disposed of in accordance with the local regulations regarding battery disposal.
- The remote control unit may function improperly if rechargeable batteries are used.

Operating range of the remote control unit

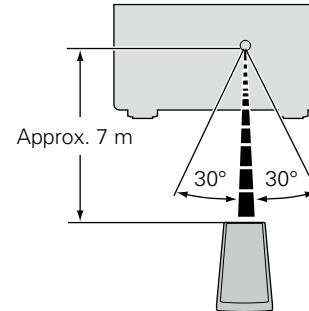

NOTE

- The set may function improperly or the remote control unit may not operate if the remote control sensor is exposed to direct sunlight, strong artificial light from an inverter type fluorescent lamp or infrared light.
- When using 3D video devices that transmit radio communication signals (such as infrared signals etc) between the various units (such as the monitor, 3D glasses, 3D transmitter unit etc), the remote control unit may not operate due to interference from those radio communication signals. If this occurs, adjust the direction and distance of the 3D communication for each unit, and check that the remote control unit operation is not affected by these signals.

Other information

Discs

Discs playable on this unit

1 Music CDs

Discs marked with the logo below can be played in this unit.



2 CD-R/CD-RW

NOTE

- Discs in special shapes (heart-shaped discs, octagonal discs, etc.) cannot be played. Do not attempt to play them, as doing so can damage the unit.
- Some discs and some recording formats cannot be played.
- Non-finalized discs cannot be played.
- What is finalization?
Finalization is the process that makes recorded CD-R/CD-RW discs playable on compatible players.



Holding discs

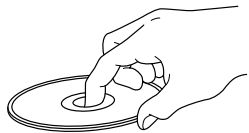

Do not touch the signal surface.

Cautions on loading discs

- Only load one disc at a time. Loading two or more discs can damage the unit or scratch the discs.
- Do not use cracked or warped discs or discs that have been repaired with adhesive, etc.
- Do not use discs on which the sticky part of cellophane tape or labels is exposed or on which there are traces of where labels have been removed. Such discs can get caught inside the player and damage it.

Loading discs

- Place the disc in the tray, label side up.
- Make sure the disc tray is fully open when inserting the disc.
- Place the discs flat, 12 cm discs in the outer tray guide (Figure 1), 8 cm discs in the inner tray guide (Figure 2).

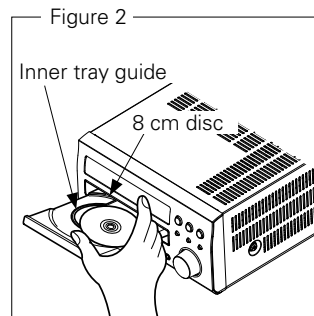
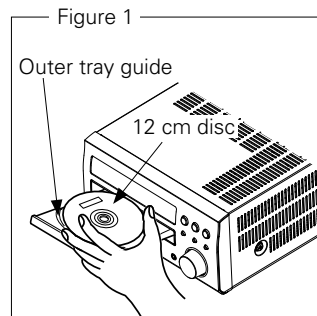

- Place 8 cm discs in the inner tray guide without using an adapter.



- "00 Tr 00 : 00" is displayed if a disc that cannot be played is loaded.
- "NO DISC" is displayed if the disc is loaded upside-down or if no disc is loaded.

NOTE

Do not push the disc tray in by hand when the power is turned off. Doing so could damage the set.

Cautions on handling

- Do not get fingerprints, oil or dirt on discs.
- Take special care not to scratch discs when removing them from their cases.
- Do not bend or heat discs.
- Do not enlarge the hole in the center.
- Do not write on the labeled (printed) surface with ball-point pens, pencils, etc., or stick new labels on discs.
- Water droplets may form on discs if they are moved suddenly from a cold place (outdoors for example) to a warm place, but do not try to dry them off using a hairdryer, etc.

Cautions on storing discs

- Be sure to remove discs after using them.
- Be sure to store discs in their cases to protect them from dust, scratches, warping, etc.
- Do not store discs in the following places:
 - Places exposed to direct sunlight for long periods of time
 - Dusty or humid places
 - Places exposed to heat from heaters, etc.

Cleaning discs

- If there are fingerprints or dirt on a disc, wipe them off before using the disc. Fingerprints and dirt can impair sound quality and cause interruptions in playback.
- Use a commercially available disc cleaning set or a soft cloth to clean discs.

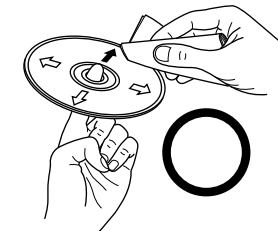

Gently wipe the disc from the inside towards the outside.

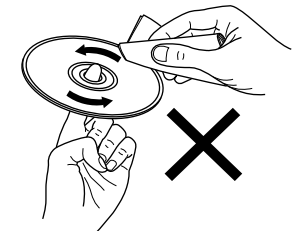

Do not wipe in a circular motion.

NOTE

Do not use record spray, antistatic agents, benzene, thinner or other solvents.

Explanation terms

A

AAC (Advanced Audio Coding)

This is an internationally standardized audio data compression scheme. It has a compression ratio 1.4 times higher than the "MP3" audio compression scheme adopted for "MPEG-1".

B

Bit rate

This expresses the read amount per 1 second of video/audio data recorded in a disc.

D

Dynamic range

The difference between the maximum undistorted sound level and the minimum sound level that is discernible above the noise emitted by the device.

F

Finalize

This is processing that enables playing back of disc of CD, which was recorded using a recorder, by other players.

M

MP3 (MPEG Audio Layer-3)

This is an internationally standardized audio data compression scheme, using the "MPEG-1" video compression standard. It compresses the data volume to about one eleventh its original size while maintaining sound quality equivalent to a music CD.

MPEG (Moving Picture Experts Group), MPEG-2, MPEG-4

These are the names for digital compression format standards used for the encoding of video and audio. Video standards include "MPEG-1 Video", "MPEG-2 Video", "MPEG-4 Visual", "MPEG-4 AVC". Audio standards include "MPEG-1 Audio", "MPEG-2 Audio", "MPEG-4 AAC".

P

Protection circuit

This is a function to prevent damage to components within the power supply when an abnormality such as an overload, excess voltage occurs or temperature for any reason.

In this unit, the power indicator blinks and the unit enters standby mode when an abnormality occurs.

S

Sampling frequency

Sampling involves taking a reading of a sound wave (analog signal) at regular intervals and expressing the height of the wave at each reading in digitized format (producing a digital signal).

The number of readings taken in one second is called the "sampling frequency". The larger the value, the closer the reproduced sound is to the original.

Speaker impedance

This is an AC resistance value, indicated in Ω (ohms). Greater power can be obtained with this value smaller.

W

WMA (Windows Media Audio)

This is audio compression technology developed by Microsoft Corporation.

WMA data can be encoded using Windows Media® Player Ver.7, 7.1, Windows Media® Player for Windows® XP and Windows Media® Player 9 Series.

To encode WMA files, only use applications authorized by Microsoft Corporation. If you use an unauthorized application, the file may not work properly.

Troubleshooting

If a problem occurs first check the following:

1. Are the connections correct?
2. Is the set being operated as described in the owner's manual?
3. Are the other components operating properly?

If this unit does not operate properly, check the items listed in the table below. If the problem persists, there may be a malfunction.

In this case, disconnect the power immediately and contact your retail outlet.

[General]

Symptom	Cause	Countermeasure	Page
Set does not operate properly.	<ul style="list-style-type: none"> External noise or interference is causing the set to malfunction. 	<ul style="list-style-type: none"> Reset the microprocessor. 	27
Display not lit and sound not produced when power switched to on.	<ul style="list-style-type: none"> Power cord not plugged in securely. 	<ul style="list-style-type: none"> Check the connections on the set's rear panel and the connection of the power plug to the power outlet. 	7
Display lit but sound not produced.	<ul style="list-style-type: none"> Wrong input source selected. Volume control set to minimum. MUTING is on. 	<ul style="list-style-type: none"> Select the appropriate input source. Turn volume up to suitable level. Switch off MUTING. 	11 11 11
Display is off.	<ul style="list-style-type: none"> The Dimmer setting is set to "OFF". 	<ul style="list-style-type: none"> Set to something other than "OFF". 	11
Power turns off suddenly and power indicator flashes red. (Flashes at 0.5 second intervals)	<ul style="list-style-type: none"> Protection circuit activated due to a rise in internal temperature. Core wires of two speakers are touching each other or a core wire is sticking out of the terminal and touching the set's rear panel, activating the protection circuit. 	<ul style="list-style-type: none"> Turn off the power, wait for the set to fully cool down, then turn the power back on. Place the set in a well-ventilated location. First unplug the power cord, then twist the core wires tightly or terminate the speaker cables, then reconnect. 	35 11 4
Power turns off suddenly and power indicator flashes red. (Flashes at 0.25 second intervals)	<ul style="list-style-type: none"> Set is damaged. 	<ul style="list-style-type: none"> Turn off the power and contact a DENON service center . 	—

[Remote control unit]

Symptom	Cause	Countermeasure	Page
Set does not work properly when Remote control unit operated.	<ul style="list-style-type: none"> Batteries are worn. You are operating outside of the specified range. Obstacle between main unit and Remote control unit. The batteries are not inserted in the proper direction, as indicated by the polarity marks in the battery compartment. The set's Remote control sensor is exposed to strong light (direct sunlight, fluorescent light, etc.). 	<ul style="list-style-type: none"> Replace with new batteries. Operate within the specified range. Remove the obstacle. Insert the batteries in the proper direction, following the polarity marks in the battery compartment. Move the set to a place in which the remote control sensor will not be exposed to strong light. 	<p>33</p> <p>33</p> <p>–</p> <p>33</p> <p>33</p>

[CD]

Symptom	Cause	Countermeasure	Page
"00 Tr 00 : 00" is shown on the display even though a CD is loaded.	<ul style="list-style-type: none"> The disc is not properly loaded. 	<ul style="list-style-type: none"> Reload the disc. 	<p>34</p>
Disc does not play when  button is pressed.	<ul style="list-style-type: none"> The disc is dirty or scratched. 	<ul style="list-style-type: none"> Wipe the disc clean or replace the disc. 	<p>34</p>
A specific part of a disc is not played.	<ul style="list-style-type: none"> The disc is dirty or scratched. 	<ul style="list-style-type: none"> Wipe the disc clean or replace the disc. 	<p>34</p>
A CD-R or CD-RW disc cannot be played.	<ul style="list-style-type: none"> The disc has not been finalized. The recording conditions are bad or the quality of the disc itself is poor. 	<ul style="list-style-type: none"> Finalize the disc then play it. Use a properly recorded disc. 	<p>34</p> <p>–</p>
MP3 and WMA files cannot be played.	<ul style="list-style-type: none"> The file formats, extensions or settings made when the disc was created are not compatible with this unit. 	<ul style="list-style-type: none"> Create discs with file formats, extensions or settings compatible with this unit. 	<p>21</p>

[Tuner]

Symptom	Cause	Countermeasure	Page
Continuous noise is heard when receiving FM programs.	<ul style="list-style-type: none"> Antenna cable is not properly connected. 	<ul style="list-style-type: none"> Connect the antenna cable properly. Connect an outdoor antenna. 	<p>6</p> <p>–</p>

[USB]

Symptom	Cause	Countermeasure	Page
When a USB memory device is connected, "USB" is not displayed.	<ul style="list-style-type: none"> The set cannot recognize a USB memory device. A USB memory device not conforming to mass storage class or MTP standards is connected. A USB memory device that the set cannot recognize is connected. USB memory device is connected via USB hub. 	<ul style="list-style-type: none"> Check the connection. Connect a USB memory device conforming to mass storage class or MTP standards. This is not a malfunction. DENON does not guarantee that all USB memory devices will operate or receive power. Connect the USB memory device directly to the USB port. 	<p>5</p> <p>–</p> <p>–</p> <p>–</p>
iPod cannot be played.	<ul style="list-style-type: none"> Input source other than "USB" is selected. Cable is not properly connected. 	<ul style="list-style-type: none"> Switch the SOURCE to "USB". Reconnect. 	<p>23</p> <p>5</p>
Files on a USB memory device cannot be played.	<ul style="list-style-type: none"> USB memory device is in a format other than FAT16 or FAT32. USB memory device is divided into multiple partitions. Files are stored in a non-compatible format. You are attempting to play a file that is copyright protected. 	<ul style="list-style-type: none"> Set the format to FAT16 or FAT32. For details, refer to the USB memory device's operating instructions. When divided into multiple partitions, only files stored in the top partition can be played. Record the files in a compatible format. Files that are copyright protected cannot be played on this set. 	<p>–</p> <p>–</p> <p>24</p> <p>24</p>

Specifications

Audio section

Power amplifier

Rated output: 30 W + 30 W (6 Ω, 1 kHz T.H.D 10 %)

Tuner section

Receiving range:

FM: 87.50 MHz – 108.00 MHz
DAB: BAND3 170 MHz – 240 MHz

Usable sensitivity:

FM: 1.2 μV/75 Ω
DAB: -93 dBm/50 Ω

FM stereo separation:

35 dB (1 kHz)

CD section

Playback frequency response:

2 Hz – 20 kHz

Wow & flutter:

Below measurable limits (± 0.001%)

Sampling frequency:

44.1 kHz

Clock/Timer section

Clock method:

Crystal oscillator (Within 1 – 2 minutes per month)

Timer:

Everyday/Once timer: One each
Sleep timer: 90 minutes, maximum

General

Power supply:

AC 230 V, 50/60 Hz

Power consumption:

70 W
Approx. 0.3 W (standby)

- For purposes of improvement, specifications and design are subject to change without notice.

Index

A

Accessories	1
Alarm	25

B

BASS	11
Bit rate	21, 24, 35
Browse mode	23

C

Cable	
Audio cable	4
Optical cable	4
Speaker cable	4
Subwoofer cable	4
Characters	14, 15, 22, 25
Condensation	2
Connection	
Antenna	6
iPod	5
Power cord	7
Speaker	4
TV	6
USB memory device	5
CT (Clock Time)	17
Current time	10

D

DAB (Digital Audio Broadcasting)	18
DAB/FM indoor antenna	6
Display	30
Display's brightness	11
Dynamic range	35

F

Finalize	34, 35
FM indoor antenna	6
Front panel	29

H

Headphones	29
------------	----

I

Input source	11
--------------	----

M

MP3	20, 21, 35
Mute	11

P

Playback	
AUX	19
CD	12
DAB	18
FM	14
iPod	23
MP3	21
USB memory device	24
WMA	21
Protection circuit	4, 35
PTY	16

R

RDS	16
Rear panel	30
Remote control unit	31
Inserting the batteries	33
Remote mode	23
Resetting the microprocessor	27
RT	17

S

Sampling frequency	21, 24, 35
SDB	11
Speaker impedance	35
Subwoofer	4

T

Tone	11
TP	17
TREBLE	11
Turning the power on	9

V

Volume	11
--------	----

W

WMA	20, 21, 35
-----	------------

Dimensions

Unit : mm

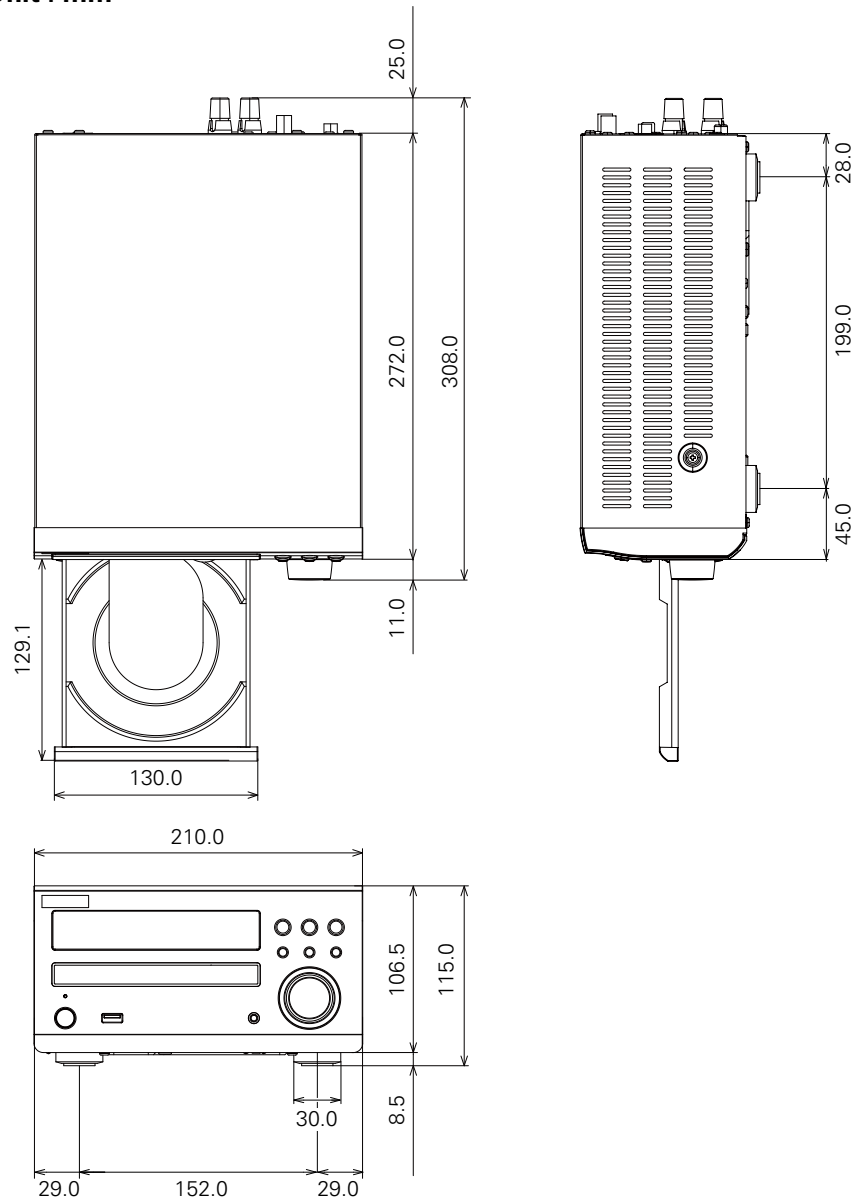

Weight : 4.0 kg

